

# NATIONAL WOOD FLOORING ASSOCIATION

## INSTALLATION GUIDELINES

### WOOD FLOORING

#### TABLE OF CONTENTS

	<u>PAGE #</u>
FORWARD	
<u>SECTION I</u> - GENERAL INFORMATION	
Chapter 1    Acceptable Jobsite Conditions	1
Chapter 2    Jobsite Checklist	3
<u>SECTION II</u> - PRODUCT INSTALLATION	
Chapter 3    Solid Parquet Floor	1
Chapter 4    Engineered Floor	9
Chapter 5    Solid Plank Floor	18
Chapter 6    Solid Strip Floor	26
<u>SECTION III</u> - SPECIAL INSTALLATION REQUIREMENTS	
Chapter 7    Truss Systems - Deflection Factor	1
Chapter 8    Radiant Heat Installation	3
Chapter 9    Sound Control Products	11
Chapter 10   Trims & Thresholds	13
<u>SECTION IV</u> - JOBSITE FINISHING & REPAIR	
Chapter 11   Bleaching	1
Chapter 12   Finish Types	3
Chapter 13   Repair	5
Chapter 14   Sand & Finish - Strip & Plank,Solid, Unfinished	8
Chapter 15   Sand & Finish - Strip & Plank,Solid, Previously Finished	12
Chapter 16   Sand & Finish - Strip & Plank, Engineered, Unfinished	15
Chapter 17   Sand & Finish - Strip & Plank, Engineered, Previously Finished	19
Chapter 18   Sand & Finish - Parquet - Solid & Engineered, Unfinished	23
Chapter 19   Sand & Finish - Parquet - Solid & Engineered,Previously Finished	27
Chapter 20   Recoating Existing Surface Finished Floor	30

SECTION V - APPENDIX

Appendix A

Moisture Testing Procedures for Concrete Slabs	Appendix AA
Moisture Testing for Wood	Appendix AB
Crawl Space Moisture Barrier Diagram	Appendix AC
Moisture by Area - United States	Appendix AD
Moisture by Area - Canada	Appendix AE
Subfloor Grade Levels	Appendix AF

Appendix B

Guide to Hardwood Flooring Grades	Appendix BA
-----------------------------------	-------------

Appendix C

Fastener Schedule	Appendix CA
-------------------	-------------

Appendix D

Applicator Recommendations	Appendix DA
Finish Chart	Appendix DB
Abrasive Guide	Appendix DC
Intercoat Abrasion	Appendix DD

Appendix E

Jobsite Checklist	Appendix EA
Tools Checklist	Appendix EB

SECTION VI - GLOSSARY OF TERMS

# **S E C T I O N I**

## **GENERAL INFORMATION**

<b>Chapter 1</b>	<b>Acceptable Jobsite Conditions</b>	<b>Page 1</b>
<b>Chapter 2</b>	<b>Jobsite Checklist</b>	<b>Page 3</b>

# SECTION I

## GENERAL INFORMATION

### CHAPTER 1

#### MINIMUM ACCEPTABLE JOBSITE CONDITIONS

Wood flooring is one of the last jobs of any construction project.

Prior to delivery of the wood flooring a site evaluation should be done. Check for the following:

The building should be completely enclosed.

All outside doors and windows must be in place and have latching mechanisms

Surface drainage should direct water away from the building.

All concrete, masonry, plastering, drywall, and other wet work should be completed and thoroughly dry.

All texturing and painting primer coats should be completed.

In warm months, the building must be well ventilated each day.

Be sure the flooring will not be exposed to extremes of humidity or moisture. Interior environmental conditions must be near the average for the geographical area. See Section V, Appendix AD or AE, Moisture by Area.

Basements must be dry.

Crawl spaces must be dry.

Crawl space must be a minimum of 18" (400 MM) from ground to underside of joists.

The crawl space earth (or thin "rat slab") must be covered 100% by a vapor retarder of 6 mil black polyethylene.

Where a proper ground covering is in place, the crawl space should have perimeter venting equal to a minimum of .1600 of the crawl space square footage.

Vents should be properly located to foster cross ventilation.

See Section V, Appendix AC, Crawl Space Moisture Diagram.

**Note: Local-building codes may differ. Local building codes prevail. Follow local building codes.**

## Chapter 1, Acceptable Jobsite Conditions

The grade level should be noted so that the correct flooring can be specified for the job. See Section V, Appendix AF, Subfloor Grades.

Subfloor (wood or concrete) should be checked by an appropriate method for establishing moisture content. Average subfloor moisture content should be within the range as specified for the product and the product specifications. Refer to Section V, Appendix AA and AB, Moisture testing procedures for concrete and wood.

Where the minimum jobsite conditions are present, the flooring can be delivered and stored in the rooms in which it will be installed.

Upon delivery check wood flooring moisture content to establish a baseline for required acclimation. Acclimate to manufacturer's recommendations or as necessary according to geographical location (See Section V, Appendix AD & AE). Acclimation can be facilitated by breaking the floor units into small lots and/or opening packaging.

**Note: Some manufacturers do not require acclimation for certain products prior to installation.**

Where building codes allow, operating permanent HVAC systems at least five days preceding installation promotes proper acclimation. Where building codes do not allow operation of the permanent system, acclimation of the flooring must be completed with the temperature and humidity maintained at or near normal living conditions between 60 to 80 degrees Fahrenheit and at the average yearly relative humidity for the area.

**Note: The moisture content of the subfloor and wood flooring should be checked by an appropriate method. There should be no more than 4% moisture content difference between properly acclimated wood flooring and subflooring materials, taking into consideration normal living conditions and equilibrium moisture content (EMC). See Section 2 and Section V, Appendix, AB.**

## II. Minimum Additional Acceptable Jobsite Conditions for Factory Finished Flooring.

All finished wall coverings and painting must be completed.

**Note: Base and shoe mold may be installed and finished after the flooring installation.**

Interior environmental conditions and moisture content of interior wood materials must be at occupied levels. Check moisture content of subflooring, trim, and exposed wood components. (See Section V Appendix AB)

# SECTION I

## GENERAL INFORMATION

### CHAPTER 2

#### JOBSITE CHECKLIST

Review plans of the installation and materials required or supplied for the job. Minimum material requirements should equal actual square footage of installed area plus 5% cutting allowance for standard installations. Review all Material Safety Data Sheets (MSDS) for each item and have them available at the jobsite.

Resolve any questions before going to job site, such as:

Do you have access to the premises for the duration of the job?

Are there restricted working hours?

On remodel work, will doors need to be cut and who will cut them and make necessary modifications to thresholds at exterior door openings?

Do you have the appropriate power for the equipment to be used, i.e. 110V, 220V, and know where it is, and does it require professional connection?

Have arrangements been made for any pets?

Have others with access been notified of work in progress?

Follow manufacturers specific installation procedures.

Check tools needed. Section V, Appendix EB, "Tools Checklist"

Be on time - if detained call & advise and check customers schedule or reschedule.

Respect the customer and their property

Be courteous - maintain a professional manner.

Do not talk about your personal problems.

Ask permission to use the bathroom and leave it as it was found.

Do not use tobacco, alcohol or drug products.

Ask to use the phone only if absolutely necessary.

Avoid discussing product, cost, procedures, etc. with the customer.

# **S E C T I O N   I I**

## **PRODUCT INSTALLATION**

<b>Chapter 3</b>	<b>Solid Parquet Floor</b>	<b>Page 1</b>
<b>Chapter 4</b>	<b>Engineered Floor</b>	<b>Page 9</b>
<b>Chapter 5</b>	<b>Solid Plank Floor</b>	<b>Page 18</b>
<b>Chapter 6</b>	<b>Solid Strip Floor</b>	<b>Page 26</b>

# SECTION II

## PRODUCT SPECIFIC INFORMATION

### CHAPTER 3

#### SOLID PARQUET FLOORING

3/4" & Thinner Unfinished/Factory Finished/Impregnated

I. Minimum Acceptable Jobsite Conditions and Checklist

See Section I

II. Acclimation Guidelines

**NOTE: Always follow the manufacturers recommendations for acclimation.**

Upon delivery check wood flooring moisture content (Section V, Appendix AB, AD and AE) to establish a baseline for required acclimation (Section 1, Chapter 1).

Acclimation depends on geographic location, interior climate control and time of year. See Definition of Acclimation under Section VI. Refer to Section V, Appendix AD and AE.

III. Flooring Grade Levels (Section V Appendix AF)

Above Grade: Solid parquet wood floors can be installed successfully above grade level.

On Grade: Solid parquet wood floors can be installed successfully on grade level.

Below Grade: SOLID WOOD FLOORS ARE NOT RECOMMENDED FOR BELOW GRADE INSTALLATIONS.

**NOTE: The entire flooring level is considered to be BELOW grade where soil is present along any perimeter wall and is more than 3" above the installed wood flooring level.**

IV. Subfloor Guidelines – Wood Joist Systems – panel products or solid boards

**NOTE: Always follow the manufacturers recommendation for proper subfloor**

**NOTE: Subfloor/Underlayment panels should conform to the US Voluntary Product Standard PS 2-92 or PS 1-95 and/or Canadian performance standard CAN/CSA 0325.0-92 Construction Sheathing. Check underside of boards for codes.**



## Chapter 3, Solid Parquet Floor

**NOTE: Solid board subflooring should be: 3/4" x 5 1/2", Group 1 dense softwoods, (SYP, Doug Fir, Larch, etc), No. 2 Common, Kiln dried less than 15% MC.**

Check subfloor for performance stamp and/or specification agency.

Subfloor must be flat, clean, dry, structurally sound, free of squeaks and free of protruding fasteners.

Test subflooring for moisture according to Moisture Testing Procedures in Section V, Appendix AB. Moisture content should be within 4% of average area environmental conditions. Section V, Appendix AD and AE.

For installations using mechanical fasteners of 1-1/2" and above, the subfloor should be flat to within 1/4" in 10' or 3/16" in 6'.

For gluedown installations and installations using mechanical fasteners of less than 1-1/2", the subfloor should be flat to within 3/16" in 10' or 1/8" in 6'.

For paneled subflooring/underlayment – nailing schedule must be adequate, typical-every 6" along panel ends and every 12" along intermediate supports; all panel edges should exhibit spacing; edge swell should be flattened as necessary.

For board subflooring – Boards should be no wider than 6"; installed at 45 degree angle with all board ends full bearing on joists and nailed with 2, 8d nails; 1/4"-1/2" space should be present between board edges.

**PREFERRED SUBFLOORING:** 3/4" (23/32", 18.3mm) CDX Plywood subfloor/underlayment (Exposure 1), 4' X 8' sheets; OR 3/4" (23/32", 18.3mm) OSB subfloor/underlayment, with joist spacing 19.2" (475mm) on center or less.

**MINIMUM:** 5/8" (19/32", 15.1mm) CDX Plywood subfloor/underlayment (Exposure 1) 4' X 8' sheets, maximum 16" (400mm) on center joist construction

Follow panel manufacturer recommendations for spacing and fastening. Typical panel spacing and fastening for joist systems, 1/8" (3.2mm) around perimeter and fastened every 6" (150mm) on bearing edges and every 12" (300 mm) along intermediate supports.

For 3/4" (18.3mm) CDX Plywood and 23/32" (18.3mm) OSB, with joist systems spaced over maximum 19.2" (475mm) o/c requires an additional layer of plywood. Minimum requirement; 1/2" (15/32", 11.9mm) CDX plywood subfloor/underlayment, (Exposure 1) 4' X 8' sheets. The 1/2" plywood should be offset by 1/2 panel in each direction to the existing subflooring. The panels may also be laid on a diagonal or perpendicular, with 1/8" spacing between sheets. Nail on a 6" minimum grid pattern-using ring shanked nails. Or brace between joists with 2X6 or wider boards every 24".

## Chapter 3, Solid Parquet Floor

### **NOTE: Parquet cannot be installed directly to solid board subfloors**

Board subfloors must have additional underlayment. Preferred requirement; 1/2" (15/32", 11.9mm) CDX plywood subfloor/underlayment, (Exposure 1) 4'x8' sheets. Minimum thickness 3/8" underlayment panels. Panels nailed on 6" minimum grid pattern using ring-shanked nails or staples.

**NOTE: With minimum specified materials, at maximum span and spacing (i.e. greater than 19.2") flooring will exhibit minimum performance. Minimum performance may result in the following conditions: movement, gaps, noises, and with site finished flooring finish delamination.**

### **V. Subfloor Guidelines – Concrete Slab**

NOTE: Always follow the manufacturers recommendation for proper subfloor.

Concrete must be flat, dry, structurally sound and clean.

Test concrete for moisture according to Moisture Testing Procedures in Section V, Appendix AA. Excess moisture should not be present.

Tolerance should be flat to within 3/16" in 10' or 1/8" in 6'.

Substrate should be flattened to tolerance

Lightweight concrete (less than 3000 psi) where adhesive used has a higher psi rating than concrete, use with a Subfloor-Floated.

RULE OF THUMB: Draw a nail across the top and if it leaves an indentation, it is probably lightweight concrete.

**Before moisture testing begins, the slab must be cured for a MINIMUM of 30 days.**

#### Direct Glue Application

**NOTE: Always follow the manufacturers recommendation for proper application, proper adhesive and correct spread rate.**

If necessary, add moisture retarder before applying adhesive. (Section V, Appendix AG)

Typical – 3/4" thick parquet requires a vapor retarder over the concrete slab, and spread rate for adhesives 30 – 50 sq. ft. per gallon.

Typical – 1/2" and thinner parquet does not require a vapor retarder, and spread rate for adhesive is 40 – 60 sq. ft. per gallon.

## Chapter 3, Solid Parquet Floor

### Subfloor – Floated

**NOTE: Always follow the manufacturers recommendation for proper subfloor**

If necessary, add moisture retarder before applying underlayment. (Section V, Appendix AG)

**PREFERRED:** Subfloor system: 2 layers 1/2" (15/32", 11.9mm) CDX plywood subfloor/underlayment, (Exposure 1) 4x8 sheets. **MINIMUM** Subfloor system: 2 layers 3/8" (10mm) CDX Plywood subfloor/underlayment (Exposure 1) 4' X 8' sheets.

Place first plywood layer with edges parallel to wall, without fastening.

Plywood should be placed with 1/8" gaps between sheets

Lay second layer perpendicular or at 45 degree angle to first

Plywood should be placed with 1/8" gaps between sheets

3/4" minimum expansion space at all vertical obstructions and wall lines

Staple, screw, or nail second layer to first layer on 12" grid pattern.

### Glue Down Subfloor

**NOTE: Always follow the manufacturers recommendation for proper subfloor**

If necessary, add moisture barrier before applying underlayment. (Section V, Appendix AA)

**PREFERRED:** Subfloor: 3/4" (23/32", 18.3mm) CDX Plywood subfloor/underlayment (Exposure 1), 4'x8' sheets. **MINIMUM** Subfloor: 5/8" (19/32), 15.1mm) CDX Plywood subfloor/underlayment, (Exposure 1), 4'x8' sheets.

For single layer system; Apply adhesive per manufacturers recommendations (typical spread rate – 30-35 sq.ft.per gallon with a 1/4"x 1/4" notched trowel), cut plywood to 2'X8' or 4'X4' sections; score on the back 1/2 the thickness on a 12"x12" grid; lay sections in a staggered joint pattern in the adhesive; 1/8" spacing between sheets; 3/4" minimum expansion space at all vertical obstructions.

### Nail Down Subfloor

**NOTE: Always follow the manufacturers recommendation for proper subfloor**

If necessary, add moisture barrier before applying underlayment.

**PREFERRED** Subfloor system: 3/4" (23/32", 18.3mm) CDX Plywood subfloor/underlayment, (Exposure 1), 4'X8' sheets. **MINIMUM** Subfloor: 5/8" (19/32, 15.1mm) CDX Plywood subfloor/underlayment (Exposure 1), 4'x8' sheets

## Chapter 3, Solid Parquet Floor

1/8" spacing between sheets with staggered joints  
Fasten every 12" and 6" from edge along the border for a minimum of 32 shots per 4'x8" sheet.  
For load (shot) information, contact your local supplier  
Areas with higher humidity may require additional nails (shots).  
3/4" minimum expansion space at all vertical obstructions

**NOTE: Fasteners may be powder driven pins, pneumatic driven nails, hand nails, screws, deformed pins, or other fasteners suitable for concrete application. Check with fastener distributor for specification such as length, drill size, and/or shot load where applicable.**

### VI. INSTALLATION

**NOTE:** The styles and types of block and parquet flooring as well as the recommended procedures for application vary somewhat among the different manufacturers. Detailed installation instructions are usually provided with the flooring or are available from the manufacturer or distributor.

Test wood subflooring for moisture according to Moisture Testing Procedures in Section V, Appendix AB. Moisture content should be within 4% of average area environmental conditions. Section V, Appendix AD and AE.

Test concrete for moisture according to Moisture Testing Procedures in Section V, Appendix AA. Moisture indicators should be within the adhesive and flooring manufacturers specifications.

A minimum expansion space equal to the thickness of the installed product must be left around the perimeter and all vertical obstructions.

Some 3/4" slat parquet can be nailed down, as long as the pattern continues to have an exposed side tongue in which to nail

Lay both blocks and the individual pieces of parquet in adhesive.

Use the wood manufacturer's approved adhesive. Follow the spread rate, trowel size and installation procedure as recommended by the adhesive manufacturer.

If recommended by manufacturer, roll floor with proper roller.

The most common layout of parquet is with edges of parquet units and the lines they form square with the walls of the room. (see figure 1-1)

## Chapter 3, Solid Parquet Floor

Start by snapping a chalk line through the center of the room (line Y (see figure 1-1)). The next line (X) must be exactly 90 degrees to line Y to form a perfect square corner. To ensure this angle, do the following:

1. From the center point (A) of line Y, measure 4 feet along line Y and mark that point (B).
2. From the same center point, measure 3 feet in the general direction of where line X will be and scribe an arc.
3. Return to the original 4-foot mark on line Y and measure 5 feet, scribing an arc that crosses (point C) the 3-foot arc you made in the previous step.
4. Verify all measurements before proceeding.
5. If correct, snap a chalk line through the conjunction of the two arcs and the center point of line Y. This will be line X, at an exact 90-degree angle to line Y.

An alternate layout is a diagonal pattern, with lines at a 45-degree angle to the walls. For diagonal layout you will start with a diagonal working line in the center of the room. (see figure 1-2)

To establish a 45-degree working line:

1. From the center point, measure 4 feet down in each direction on lines X and Y.
2. From each of these points, measure 4 feet and scribe an arc. The conjunction of these arcs creates points D and E.
3. Snap a chalk line between points D and E, and the center point. This line represents a 45-degree angle.

Most special patterns can be laid out with the above two working lines. Herringbone will require two lines, one at 90 degrees and the other at a 45-degree angle. These lines must be adjusted to properly center the points of the pattern. *Herringbone direction should be installed in accordance with consumer preference. If the pattern is to be installed in the direction of the length of the room, the herringbone working line should be laid out parallel to line Y. (see figure 1-3 and figure 1-4). Line B in this instance must run parallel to line Y and represent the center of the herringbone material. To determine the center of the herringbone material and establish line B:*

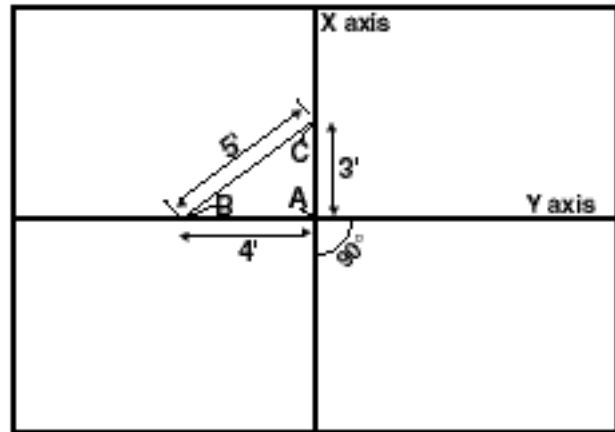

figure 1-1

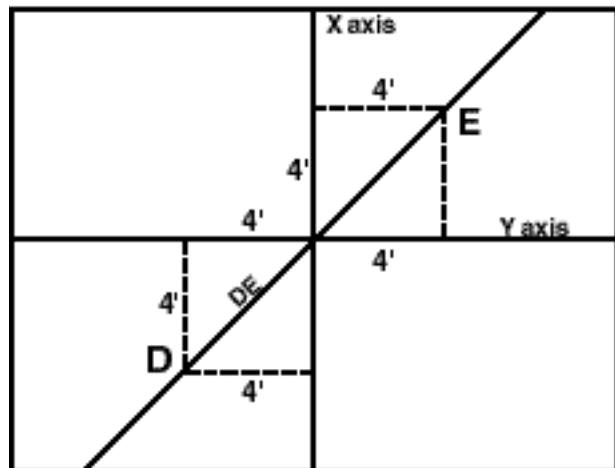

figure 1-2

## Chapter 3, Solid Parquet Floor

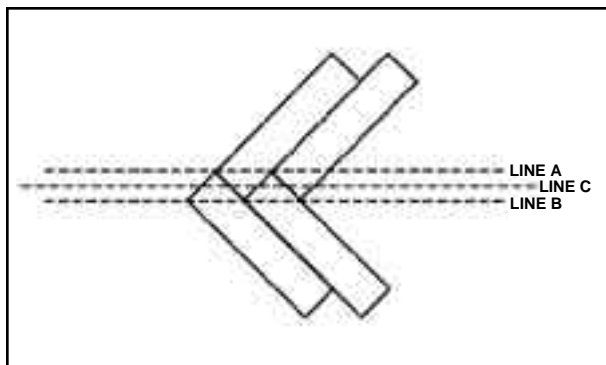

figure 1-3

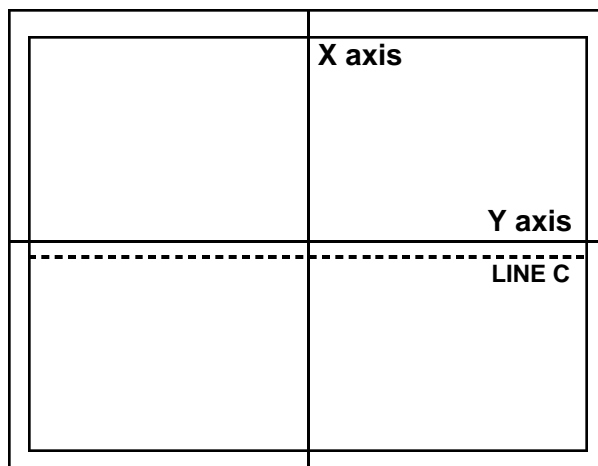

figure 1-4

1. Begin by laying out a few alternating slats. (see figure 1-4)
2. Snap line A and line B through the corners of the alternating slats.
3. Measure the distance from line A to line B. The working line should be one-half that distance and run parallel to line Y.

*Herringbone installation: To begin installation on line B (see figure 1-5), cut a square piece of plywood the size of the herringbone pattern you are installing. For example, if the herringbone is 3 inches by 12 inches, cut a 12-by-12 inch piece of plywood. Nail this piece of plywood at your starting point on line B, with one corner of the square pointing in the direction of your layout.*

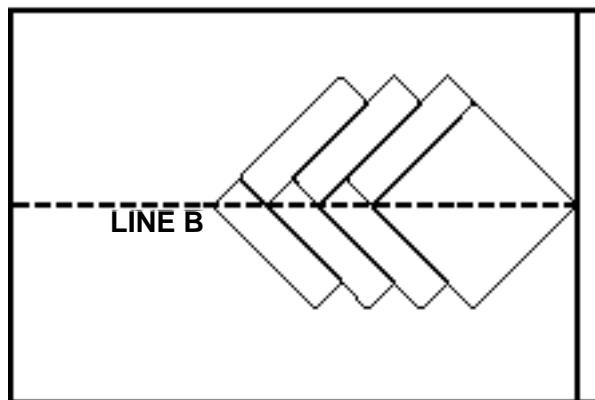

figure 1-5

### VI. EXISTING FLOORING GUIDELINES

**NOTE: Always follow the manufacturers recommendations for installation over existing flooring.**

Glue down parquet applications that require the use of PVA adhesives is not recommend over existing sheet vinyl or vinyl and cork tile flooring unless an underlayment is put down first. Underlayment should be in accordance with preceding NWFA guidelines.

Other types of adhesives may require the use of a primer or vinyl blocker when installing over sheet vinyl or vinyl and cork tile flooring.

## Chapter 3, Solid Parquet Floor

Nail down applications may be successful over existing sheet vinyl or vinyl tile if fastener penetration is not significantly diminished and the subfloor meets minimum requirements.

**NOTE: Particleboard is not generally an acceptable underlayment. Some manufacturers approve particleboard as an acceptable underlayment. In such cases follow manufacturers recommendation.**

Sand off old finish and high spots on existing wood floor and prep to clean, dry, sound, flat subfloor. Repair, re-nail or replace loose flooring products.

Wood Flooring can be installed over existing ceramic tile, terrazzo, or marble with proper underlayment or adhesives only on manufacturers recommendation.

# SECTION II

## PRODUCT SPECIFIC INFORMATION

### CHAPTER 4

#### ENGINEERED WOOD FLOORS

##### Multi-ply wood flooring – Strip, Plank, and Parquet – Unfinished/Factory Finished/Impregnated

I. Minimum Acceptable Jobsite Conditions and Checklist See Section I

II. Acclimation Guidelines

**NOTE: Always follow the manufacturer's recommendation for acclimation.**

Upon delivery check wood flooring moisture content (Section V, Appendix AB, AD, and AE) to establish a baseline for required acclimation (Section I, Chapter 1).

Acclimation depends on geographic location, interior climate control and time of year. See Definition of Acclimation under Section VI. Refer to Section V, Appendix AD and AE.

III. Flooring Grade Levels (Section V, Appendix AF)

Above Grade: Engineered wood floors can be installed successfully above grade level.

Engineered wood floors can be installed direct to concrete or wood subfloor.

On Grade: Engineered wood floors can be installed successfully on grade level.

Engineered wood floors can be installed direct to concrete or wood subfloor.

Below Grade: Engineered wood floors can be installed successfully below grade level.

Engineered wood floors can be installed direct to concrete or wood subfloor.

**NOTE: The entire flooring level is considered to be BELOW grade where soil is present along any perimeter wall and is more than 3" above the installed wood flooring level. Ground should be sloped away from the house for proper drainage. Check local building codes. Local building codes prevail. Follow local building codes.**

IV. Subfloor Guidelines – Wood Joist Systems – panel products or solid boards

**NOTE: Always follow the manufacturers recommendation for proper subfloor**



## Chapter 4, Engineered Floor

**NOTE: Subfloor/Underlayment panels should conform to the US Voluntary Product Standard PS 2-92 or PS 1-95 and/or Canadian performance standard CAN/CSA 0325.0-92 Construction Sheathing. Check underside of boards for codes.**

**NOTE: Solid board subflooring should be: 3/4" X 5 1/2", Group 1 dense softwoods (SYP, Doug Fir, Larch, etc.), No. 2 Common, Kiln dried less than 15% MC.**

Check subfloor for performance stamp and/or specification agency.

Subfloor must be flat, clean, dry, structurally sound and free of squeaks and free of protruding fasteners.

Test subflooring for moisture according to Moisture Testing Procedures in Section V, Appendix AB. Moisture content should be within 4% of average area environmental conditions. Section V, Appendix AD and AE.

For installations using mechanical fasteners of 1-1/2" and above, the subfloor should be flat to within 1/4" in 10' or 3/16" in 6'.

For gluedown installations and installations using mechanical fasteners of less than 1-1/2", the subfloor should be flat to within 3/16" in 10' or 1/8" in 6'.

For paneled subflooring/underlayment – nailing schedule must be adequate, typical – every 6" along panel ends and every 12" along intermediate supports; all panel edges should exhibit spacing; edge swell should be flattened as necessary.

For board subflooring – Boards should be no wider than 6"; installed at 45 degree angle with all board ends full bearing on joists and nailed with 2, 8d nails; 1/4" – 1/2" space should be present between board edges.

**PREFERRED SUBFLOORING:** 3/4" (23/32, 18.3mm) CDX grade Plywood subfloor/underlayment (Exposure 1), 4' X 8' sheets, OR 3/4" (23/32" 18.3mm) OSB subfloor/underlayment grade, with joist spacing 19.2" (475 mm) on center or less.

**MINIMUM SUBFLOORING:** 5/8" (19/32", 15.1mm) CDX Plywood subfloor/underlayment (Exposure 1), 4' X 8' sheets, maximum 16" (400mm) on center joist construction.

Follow panel manufacturer recommendations for spacing and fastening. Typical panel spacing and fastening for joist systems, 1/8" (3.2mm) around perimeter and fastened every 6" (150mm) on bearing edges and every 12" (300mm) along intermediate supports.

## Chapter 4, Engineered Floor

For 3/4" (19mm) CDX Plywood and 23/32" (19mm) OSB, with joists spaced over 19.2" (475mm) on center or 5/8" CDX Plywood with joists systems spaced over 16" (400mm) on center an additional layer of plywood is required. Minimum requirement: 1/2" (15/32", 11.9mm) CDX plywood subfloor/underlayment, Exposure 1), 4'x8' sheets. The panels may also be laid on a diagonal or perpendicular, with 1/8" spacing between sheets. Nail on a 6" (150mm) minimum grid pattern using ring shanked nails. Or brace between joists with 2X6 or wider boards every 24".

**NOTE: Some Engineered flooring cannot be installed directly to solid board subfloors. (see manufacturers recommendation)**

Board subfloors must have additional underlayment. Preferred requirement: 1/2" (15/32", 11.9mm) CDX plywood subfloor/underlayment, Exposure 1, 4'X8' sheets. Minimum thickness 3/8" underlayment panels. Panels nailed 6" minimum grid pattern using ring shanked nails or staples.

**NOTE: With minimum specified materials, at maximum span and spacing (i.e. greater than 19.2") plank flooring will exhibit minimum performance. Minimum performance may result in the following conditions: movement, gaps, noises, and with site finished flooring, finish delamination.**

### V. Subfloor Guidelines – Concrete Slab

Concrete must be flat, dry, structurally sound and clean.

Test concrete for moisture according to Moisture Testing Procedures in Section V, Appendix AA. Excess moisture should not be present.

Tolerance should be flat to within 3/16" in 10' or 1/8" in 6'.

Substrate should be flattened to tolerance.

Lightweight concrete (less than 3000 psi) – Where adhesive used has a higher psi rating than concrete, use with a Subfloor-Floated.

RULE OF THUMB: Draw a nail across the top and if it leaves an indentation, it is probably lightweight concrete. If psi of concrete unknown use Subfloor-Floated.

**Before moisture testing begins, the slab must be cured for a MINIMUM of 30 days.**

#### Direct Glue Application

**NOTE: Always follow the manufacturers recommendation for proper application, proper adhesive, and correct spread rate.**

## Chapter 4, Engineered Floor

Typical – spread rate for adhesive 40 – 60 sq. ft. per gallon.

### Subfloor-Floated

If necessary, add moisture barrier before applying underlayment. (Section V, Appendix AG)

**PREFERRED** Subfloor system: 2 layers 1/2" (15/32", 11.9mm) CDX Plywood subfloor/underlayment (Exposure 1), 4'X 8' sheets. **MINIMUM** Subfloor system: 2 layers 3/8" (10mm) CDX plywood subfloor/underlayment, (Exposure 1), 4'x8' sheets.

Place first plywood layer with edges parallel to wall, without fastening.  
Plywood should be placed with 1/8" gaps between sheets  
Lay second layer perpendicular or at 45 degree angle to first  
Plywood should be placed with 1/8" gaps between sheets  
3/4" minimum expansion space at all vertical obstructions and wall lines  
Staple, screw, or nail second layer to first layer on 12" grid pattern.

### Glue Down Subfloor

**NOTE: Always follow the manufacturers recommendation for proper subfloor**

If necessary, add moisture barrier before applying underlayment. (Section V, Appendix AG)

**PREFERRED** Subfloor: 3/4" (23/32", 18.3mm) CDX Plywood subfloor/underlayment (Exposure 1), 4'x8' sheets. **MINIMUM** Subfloor: 5/8" (19/32), 15.1mm) CDX Plywood subfloor/underlayment, (Exposure 1), 4'x8' sheets.

For single layer system; Apply adhesive per manufacturers recommendations (typical spread rate – 30-35 sq.ft. per gallon with a 1/4"x 1/4" notched trowel), cut plywood to 2'X8' or 4'X4' sections; score on the back 1/2 the thickness on a 12"x12" grid; lay sections in a staggered joint pattern in the adhesive; 1/8" spacing between sheets; 3/4" minimum expansion space at all vertical obstructions.

### Nail Down Subfloor

**NOTE: Always follow the manufacturers recommendation for proper subfloor**

If necessary, add moisture barrier before applying underlayment.

**PREFERRED** Subfloor system: 3/4" (23/32", 18.3mm) CDX Plywood subfloor/underlayment, (Exposure 1), 4'X8' sheets. **MINIMUM** Subfloor: 5/8" (19/32, 15.1mm) CDX Plywood subfloor/underlayment (Exposure 1), 4'x8' sheets

## Chapter 4, Engineered Floor

1/8" spacing between sheets with staggered joints

Fasten every 12" and 6" from edge along the border for a minimum of 32 shots per 4'x8" sheet.

For load (shot) information, contact your local supplier

Areas with higher humidity may require additional nails (shots).

3/4" minimum expansion space at all vertical obstructions

**NOTE: Fasteners may be powder driven pins, pneumatic driven nails, hand nails, screws, deformed pins, or other fasteners suitable for concrete application. Check with fastener distributor for specification such as length, drill size, and/or shot load where applicable.**

### Screed System

Engineered wood flooring cannot be installed directly to screeds. Screed System must be overlaid with proper subflooring, see IV. Subfloor Guidelines – Wood Joist Systems – panel products or solid boards this chapter.

Screeds should be 2"X4" or 2"X3", Group 1 species, pressure treated, kiln-dried after treatment to 12% m.c. or less; flat, with minimum twist or crook, cut as necessary to maintain flatness, typical, 18"-48" in length; lay in runs maximum 16" on center at right angles to flooring direction; set screeds widest dimension in adhesive with 100% contact; use cold bond adhesive or adhesive approved by the manufacturer; lap along sides at end joints 3"-4" with 1/8" spacing between; stagger all screen end joints; leave 3"-4" space at all vertical obstructions; apply necessary vapor retarder. See Section V, Appendix AG.

### Existing flooring guidelines

**NOTE: Always follow the manufacturer's recommendation for installation over existing flooring.**

Glue down applications of Engineered wood flooring may be successful over existing sheet vinyl or vinyl tile. Some types of adhesives may require the use of a primer or vinyl blocker when installing over this type of surface.

Nail or staple down applications may be successful over existing sheet vinyl or vinyl tile if fastener penetration is not significantly diminished and the subfloor meets minimum requirements. (Particle board is not an acceptable underlayment)

Where present old finish should be removed from an existing floor. Subflooring should be flattened to tolerance should be flat to within 3/16" in 10' or 1/8" in 6'.

## Chapter 4, Engineered Floor

Substrate should be clean, dry, and sound. Repair, re-nail or replace loose flooring products.

**NOTE: Only on manufacturer's recommendation can engineered wood flooring be installed over existing ceramic tile, terrazzo or marble. Contact manufacturer in all cases for proper adhesive and/or underlayment recommendation.**

### VI. INSTALLATION:

The styles and types of engineered wood flooring as well as the recommended procedures for application vary somewhat among the different manufacturers. Detailed installation instructions are usually provided with the flooring or are available from the manufacturer or distributor.

**NOTE: Always follow the manufacturer recommended installation procedure.**

#### Glue Down Engineered Strip and Plank

There are several different ways to start the installation of glue-down engineered wood flooring. The following has proven successful where instructions differ from manufacturer recommendations, manufacturer recommendations prevail.

Test substrate for moisture according to appropriate Moisture Testing Procedures in Section V. Excessive/elevated moisture should not be present. Subfloor should be within acceptable moisture content as per manufacturer recommendation before installing.

Expansion space should be left around the perimeter or in accordance with manufacturer recommendation. Typical expansion is equal to the thickness of the product installed.

Snap a working line parallel to the starting wall, out approximately 3 feet, in multiples of the pattern width.

Use an adhesive approved by the flooring manufacturer. Follow the installation procedure recommended by the adhesive manufacturer, which includes; spread rate, trowel size, open time, working time, and flash time as necessary. Spread the adhesive as instructed up to and along the working line.

Install a sacrificial row along the edge of the working line and begin installation. (Before finishing the installation remove sacrificial row and complete installation or alternatively, lay one row of plank in the adhesive along the entire length of the working line. Follow manufacturer instruction for tongue and groove direction and placement procedure. Add each additional row of flooring. Maintain proper pattern repeat, distribute lengths avoiding "H" patterns and end joints less than

## Chapter 4, Engineered Floor

6 inches in adjacent runs; if recommended use tape or tensioners to maintain a tight floor.

If recommended by manufacturer, roll floor with proper roller.

### Mechanically Fastened Engineered Strip and Plank

If necessary, add moisture retarder before applying underlayment. (Section V, Appendix AG)

Stretch or snap a working line parallel to the starting wall allowing expansion space as the manufacturer recommends. Typical expansion is equal to the thickness of product installed.

Lay one row of plank along the entire length of the working line. Use appropriate size fastener for top nailing first row, last row and any area where nailer will not fit. Space fasteners at 6-8 inch intervals.

Add each additional row of flooring. Maintain proper pattern repeat, distribute lengths avoiding "H" patterns and end joints less than 6 inches in adjacent runs.

During installation of flooring pieces, gently tap boards flush to the previous row. Always tap against the tongue, tapping the groove may damage the surface or edge.

Fasten flooring through the tongue on a 45 degree angle ("blind nailing") using recommended fasteners. Typical, narrow crowned (1/4") 1" staples or 1" – 1 1/4" hardwood flooring cleats spaced as recommended by the manufacturer or every 4-8 inches.

### Glue Down Engineered Parquet

Test substrate for moisture according to appropriate Moisture Testing Procedures in Section V. Excessive/elevated moisture should not be present. Subfloor should be within acceptable moisture content as per manufacturers recommendation before installing.

The most common layout of parquet is with edges of parquet units (and the lines they form) square with the walls of the room. Center, working lines on prominent physical features of room, e.g. doorway(s), bay window(s), fireplace, etc., or mid points of walls. Working lines should be perpendicular to each other.

An alternate layout is a diagonal pattern, with lines at a 45-degree angle to the walls. Snap chalk lines as described above and then snap diagonal chalk lines at a 45-degree angle to the square lines.

## Chapter 4, Engineered Floor

Most special patterns can be laid out with the above two working lines. Herringbone will require two lines, one at 90 degrees and the other at a 45-degree angle. These lines must be adjusted to properly center the points of the pattern.

Expansion space should be left around the perimeter or in accordance with manufacturers recommendation. Typical expansion is equal to the thickness of product installed.

Use an adhesive approved by the flooring manufacturer. Follow the installation procedure recommended by the adhesive manufacturer, which includes; spread rate, trowel size, open time, working time, and flash time as necessary. Spread the adhesive as instructed up to and along the working lines.

If recommended by manufacturer, roll floor with proper roller.

### Floating Engineered Flooring

Test substrate for moisture according to appropriate Moisture Testing Procedures in Section V. Excessive/elevated moisture should not be present. Subfloor should be within acceptable moisture content as per manufacturers recommendation before installing.

If necessary, add moisture retarder before applying underlayment (Section V, Appendix AG)

Expansion space should be left around the perimeter or in accordance with manufacturers recommendation. Typical expansion is equal to the thickness of product installed.

Typically, subfloors are covered with a resilient material; foam or cork. Follow manufacturers instructions for correct materials and thickness.

Typically, floating engineered flooring is edge glued. Use an adhesive approved by the manufacturer. Apply adhesive at the spread rate to the side grooves and/or ends as recommended by the manufacturer. **Tapping block should be used against tongue only.**

Stagger end joints per manufacturers recommendation. Typical, 18-20".

## **XI. EXISTING FLOORING GUIDELINES**

NOTE: Always follow the manufacturer's recommendations for installation over existing flooring.

## Chapter 4, Engineered Floor

Glue down applications of Engineered wood flooring may be successful over existing sheet vinyl or vinyl tile. Some types of adhesives may require the use of a primer or vinyl blocker when installing over this type of surface.

Nail or staple down applications may be successful over existing sheet vinyl or vinyl tile if fastener penetration is not significantly diminished and the subfloor meets minimum requirements. (Particle board is not an acceptable underlayment.)

Sand off old finish and high spots on existing wood floor and prep to clean, dry, sound, flat subfloor. Repair, renail or replace loose flooring products.

Wood Flooring can be installed over existing ceramic tile, terrazzo, or marble with proper underlayment or adhesives only on manufacturer's recommendation.



# SECTION II

## PRODUCT SPECIFIC INFORMATION

### CHAPTER 5

#### SOLID PLANK FLOOR

##### TONGUE AND GROOVE:

3/4" X 3", 4", 5", 6", 7" and up Unfinished/Factory Finished

I. Minimum Acceptable Jobsite Conditions and Checklist See Section 1

**NOTE:** With wider plank flooring, environmental conditions associated with a factory finished flooring product should be present.

II. Acclimation Guidelines

**NOTE:** Always follow the manufacturer's recommendation for acclimation.

Upon delivery check wood flooring moisture content (Section V, Appendix AB, AD and AE) to establish a baseline for required acclimation (Section 1, Chapter 1).

Acclimation depends on geographic location, interior climate control and time of year. See Definition of Acclimation under Section VI. Refer to Section V, Appendix AD and AE.

III. Subfloor Grade Levels (Section V, Appendix AF)

Above Grade: Solid plank wood floors can be installed successfully above grade level.

On Grade: Solid plank wood floors can be installed successfully on grade level.

Below Grade: SOLID WOOD FLOORS ARE NOT RECOMMENDED FOR BELOW GRADE INSTALLATIONS.

**NOTE:** The entire flooring level is considered to be BELOW grade where soil is present along any perimeter wall and is more than 3" above the installed wood flooring level. Ground should be sloped away from the house for proper drainage. Check local building codes. Local building codes prevail. Follow local building codes.

IV. Subfloor Guidelines – Wood Joist Systems – panel products or solid boards

**NOTE:** Always follow the manufacturers recommendation for proper subfloor

## Chapter 5, Solid Plank Floor

**NOTE: Subfloor/Underlayment panels should conform to the US Voluntary Product Standard PS 2-92 or PS 1-95 and/or Canadian performance standard CAN/CSA 0325.0-92 Construction Sheathing. Check underside of boards for codes.**

**NOTE: Solid board subflooring should be: 3/4" x 5 1/2", Group 1 dense softwoods, (SYP, Doug Fir, Larch, etc), No. 2 Common, Kiln dried less than 15% MC.**

Check subfloor for performance stamp and/or specification agency.

Subfloor must be flat, clean, dry, structurally sound and free of squeaks and free of protruding nails/staples.

Test subflooring for moisture according to Moisture Testing Procedures in Section V, Appendix AB. Moisture content should be within 4% of average area environmental conditions. Section V, Appendix AD and AE.

For installations using mechanical fasteners of 1-1/2" and above, the subfloor should be flat to within 1/4" in 10' or 3/16" in 6'.

For paneled subflooring/underlayment – nailing schedule must be adequate, typical-every 6" along panel ends and every 12" along intermediate supports; all panel edges should exhibit spacing; edge swell should be flattened as necessary.

For board subflooring – Boards should be no wider than 6"; installed at 45 degree angle with all board ends full bearing on joists and nailed with 2, 8d nails; 1/4"-1/2" space should be present between board edges.

**PREFERRED SUBFLOORING:** 3/4" (23/32", 18.3mm) CDX Plywood subfloor/underlayment (Exposure 1), 4' X 8' sheets; OR 3/4" (23/32", 18.3mm) OSB subfloor/underlayment, with joist spacing 19.2" (475mm) on center or less.

**MINIMUM:** 5/8" (19/32", 15.1mm) CDX Plywood subfloor/underlayment (Exposure 1) 4' X 8' sheets, maximum 16" (400mm) on center joist construction.

Follow panel manufacturer recommendations for spacing and fastening. Typical panel spacing and fastening for joist systems, 1/8" (3.2mm) around perimeter and fastened every 6" (150mm) on bearing edges and every 12" (300 mm) along intermediate supports.

**NOTE: With minimum specified materials, at maximum span and spacing (i.e. greater than 19.2") plank flooring will exhibit minimum performance.**

**Minimum performance may result in the following conditions: movement, gaps, noises, and with site finished flooring finish delamination.**

## Chapter 5, Solid Plank Floor

For 3/4" (18.3mm) CDX Plywood and 23/32" (18.3mm) OSB, with joist systems spaced over maximum 19.2" (475mm) o/c requires an additional layer of plywood is required. Minimum requirement; 1/2" (15/32", 11.9mm) CDX plywood subfloor/underlayment,(Exposure 1) 4'X8'sheets. The 1/2"plywood should be offset by 1/2 panel in each direction to the existing subflooring. The panels may also be laid on a diagonal or perpendicular, with 1/8" spacing between sheets. Nail on a 6" minimum grid pattern-using ring shanked nails. Or brace between joists with 2X6 or wider boards every 24".

### V. Subfloor Guidelines – Concrete Slab

NOTE: Always follow the manufacturers recommendation for proper subfloor.

Concrete must be flat, dry, structurally sound and clean.

**NOTE: A moisture retarder with permeance equivalent to 4-mil polyethylene film is always required over the concrete slab and below the subflooring material.**

Test concrete for moisture according to Moisture Testing Procedures in Section V, Appendix AA. Excess moisture should not be present.

Tolerance should be flat to within 3/16" in 10' or 1/8" in 6'.

For installations using mechanical fasteners of 1-1/2" and above, the subfloor should be flat to within 1/4" in 10' or 3/16" in 6'.

Substrate should be flattened to tolerance

Lightweight concrete (less than 3000 psi) where adhesive used has a higher psi rating than concrete, use with a Subfloor-Floated.

RULE OF THUMB: Draw a nail across the top and if it leaves an indentation, it is probably lightweight concrete, use Subfloor-Floated.

**Before moisture testing begins, the slab must be cured for a MINIMUM of 30 days.**

NAIL DOWN PLANK FLOORING MUST HAVE AN APPROVED SUBFLOOR OVER THE CONCRETE. PLANK CAN NOT BE SHOT TO THE CONCRETE. 3/4" PLANK CANNOT BE DIRECT GLUED TO CONCRETE. PLANK CANNOT BE GLUED AND NAILED DIRECT TO CONCRETE.

**NOTE: Some manufacturers suggest direct glue installation of 3/4" plank in lengths less than 11 1/4". In such cases follow manufacturers recommendation.**

NOTE: A MOISTURE RETARDER IS RECOMMENDED ANYTIME SOLID WOOD FLOORING IS INSTALLED OVER CONCRETE.

## Chapter 5, Solid Plank Floor

### Subfloor – Floated

**NOTE: Always follow the manufacturers recommendation for proper subfloor**

Add moisture barrier before applying underlayment. (Section V, Appendix AG)

PREFERRED Subfloor system: 2 layers 1/2" (15/32", 11.9mm) CDX Plywood subfloor/underlayment (Exposure 1), 4'X 8' sheets. MINIMUM Subfloor system: 2 layers 3/8" (10mm) CDX plywood subfloor/underlayment, (Exposure 1), 4'x8' sheets.

Place first plywood layer with edges parallel to wall, without fastening.

Plywood should be placed with 1/8" gaps between sheets

Lay second layer perpendicular or at 45 degree angle to first

Plywood should be placed with 1/8" gaps between sheets

3/4" minimum expansion space at all vertical obstructions and wall lines

Staple, screw, or nail second layer to first layer on 12" grid pattern.

ALTERNATE Subfloor: 3/4" (23/32", 18.3mm) CDX Plywood sheathing, (Exposure 1), 4'x8' sheets; cut to 16"X8' planks, scored on back 3/8" deep every 12" across width, 16" planks oriented perpendicular to direction of flooring, panels staggered every 2", and spaced 1/8" between ends and 1/4" to 3/4" between edges. 3/4" minimum expansion space at all vertical obstructions.

### Glue Down Subfloor

**NOTE: Always follow the manufacturers recommendation for proper subfloor**

Add moisture barrier before applying underlayment. (Section V, Appendix AG)

PREFERRED Subfloor: 3/4" (23/32), 18.3mm) CDX Plywood sheathing, (Exposure 1), 4'x8' sheets.

For single layer system; Apply adhesive per manufacturers recommendations (typical spread rate – 30-35 sq.ft.per gallon with a 1/4"x 1/4" notched trowel), cut plywood to 16"X8' planks, or 2'x8' sections or 4'x4' sections, scored on back 3/8" deep (scoring for 16" planks every 12" across width, for 2' and 4' sections on a 12"X12" grid). 16" planks and 2' sections oriented perpendicular to direction of flooring, panels, staggered every 2', and spaced 1/8" between ends and 1/4" to 3/4" between edges. Space 4'x4' sections 1/8" to 1/4"

3/4" minimum expansion space at all vertical obstructions.

### Nail Down Subfloor

**NOTE: Always follow the manufacturers recommendation for proper subfloor**

## Chapter 5, Solid Plank Floor

Add moisture barrier before applying underlayment.

PREFERRED Subfloor system: 3/4" (23/32", 18.3mm) CDX Plywood subfloor/underlayment, (Exposure 1), 4'X8' sheets.

Use full 4'x8' sheets or cut to 16"X8' planks, or 2'x8' sections. Full sheets oriented at 45 degrees (preferred) or perpendicular to direction of flooring. 16" planks and 2' sections oriented perpendicular to direction of flooring staggered every 2'. Space 1/8" between ends and 1/4" to 3/4" between panel edges. Panels are staggered, full sheets by 1/2" sheet for planks and sections every 2'.

Fasten every 12" and 6" from edge along the border for a minimum of 32 shots per 4'x8" sheet.

For 2' sections and 16" planks fasten every 12" along the length with 1 or 2 fasteners equally spaced from edges.

3/4" minimum expansion space at all vertical obstructions

**NOTE:** Fasteners may be powder driven pins, pneumatic driven nails, hand nails, screws, deformed pins, or other fasteners suitable for concrete application. Check with fastener distributor for specification such as length, drill size, and/or shot load where applicable.

### Screed System

**NOTE: Plank flooring 4" and wider cannot be installed directly to screeds.**

Screed System must be overlaid with 3/4" (23/32" 18.3mm) Exposure 1, or 5/8" (19/32" 15.1mm), Exposure 1, CDX plywood subfloor/underlayment or 3/4" (23/32", 18.3mm) OSB underlayment properly spaced and oriented perpendicular to screed direction.

Screeds. 2"X 4" or 2"X 3" Group 1 species, pressure treated, kiln dried after treatment to 12% m.c. or less should be flat with minimum twist or crook, cut as necessary to maintain flatness, 18" - 48" long.

Use adhesive approved by the manufacturer

Set screeds with widest dimension in rivers of adhesive for 100% contact, space 1/8" at end joints, screed joints should be staggered and not fall directly under subfloor panel edges.

Lay screed runs maximum 16" on center at right angles to direction of finished floor, leaving 3/4" expansion at all vertical obstructions.

Lay 6-8 mil poly film over screeds

## Chapter 5, Solid Plank Floor

### VI. INSTALLATION

**NOTE:** Always follow the manufacturers recommended installation procedure.

Unfinished/Factory finished solid plank should be installed perpendicular to the joists or on a diagonal for any single layer subfloor. (exception, diagonal, solid subfloor boards, install perpendicular to joist or subfloor direction).

CAUTION: When laying 3/4" solid plank flooring parallel with the floor joists either add an additional layer of minimum 1/2" (15/32") CDX plywood underlayment to the existing subfloor (as previously recommended) or brace between joists with 2" X 6" or wider boards every 24" minimum. Subfloor must be within 4% moisture content of the hardwood floor before installing. Refer to Section V, Appendix AB.

Before installing wood flooring place 15 lb. asphalt saturated felt paper that meets ASTM Standard D4869 or use a building paper with an equivalent permeance over wood subfloor. REFER TO MANUFACTURERS RECOMMENDATION BEFORE PROCEEDING.

Snap a working line parallel to the starting wall allowing 3/4" expansion space between the starting wall and the edge of the first plank run.

A 3/4" expansion space must be left around the perimeter and at all vertical obstructions.

Plank is laid out in the same manner as strip flooring, alternating courses by widths. Start with the widest board, then the next width, etc., and repeat the pattern.

Lay one row of plank along the entire length of the working line.

Top and blind nail the first row (hand nail if necessary), using appropriate fasteners. Each succeeding row should be blind nailed with the nailing machine wherever possible. At the finishing wall and other obstructions, it may be necessary to blind nail by hand until top nailing is required.

Racking rule of thumb: Stagger end joint a minimum of 6" between pieces on adjacent rows, see figure 1-1. Avoid H joints

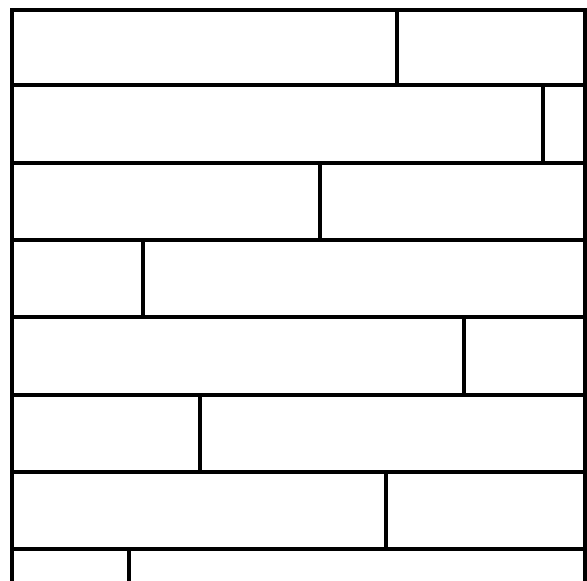

Figure 1-1 ACCEPTABLE

## Chapter 5, Solid Plank Floor

Add each additional row of flooring, watching the pattern repeat and offsetting or staggering the end joints at least 6 inches.

On floors wider than 20' to minimize expansion: More or less spacing may be needed depending on geographical area, interior climate control and time of the year.. In some areas, additional spacing may not be necessary.

Where spacing is required: Use a washer or removable spacer to leave additional space every few rows and/or start in center of room and work out to both sides.

Nailing: Blind nail through the tongue using 2" barbed flooring cleat, 7d or 8d flooring nail, or 2" (15 gauge) staples with 1/2" crown. Use 1 1/2" length, fasteners with 3/4" plywood subfloor direct to concrete slab. Face nail boards where needed using 7d or 8d flooring nail – casing nail – galvanized nail – finishing nail, or flooring cleat. Fasteners should be spaced every 8".

For additional fastening, any of the following options may be used in addition to the nailing schedule.

FOLLOW Manufacturer's instructions for installing Plank Flooring.

It is general practice to countersink one or more No. 9 or No. 12 screws at each end of each plank. The wider the plank the more the general practice is used. Fill with wood putty or use plugs of the same or contrasting species as desired. Appropriate mastic may be applied to the ends of each board and/or on back or to the subfloor in addition to nailing schedule. This will make repair/replacement of boards very difficult.

Blind nail and face nail, as necessary, to complete the final rows.

## **VI. EXISTING FLOORING GUIDELINES**

**NOTE: Always follow the manufacturer's recommendations for installation over existing flooring.**

Check existing flooring for soundness and repair and refasten as necessary.

Wood flooring can be nailed directly into existing sheet vinyl or vinyl tile if the subfloor is within NWFA guidelines (5/8" or thicker CDX grade plywood underlayment or 3/4"(23/32") or thicker OSB Underlayment Grade. (Particleboard is not an acceptable underlayment.)

Wood flooring can be nailed to existing flat, dry and structurally sound solid strip or plank wood floors by sanding high spots and laying the floor at a 45 to 90

## Chapter 5, Solid Plank Floor

degree angle to the existing wood floor. Adding an additional 1/2" underlayment (minimum 3/8") allows for the floor to be installed in any direction.

Wood flooring can be installed over existing ceramic tile, terrazzo, or marble with proper underlayment only on manufacturers recommendation.



# SECTION II

## PRODUCT SPECIFIC INFORMATION

### CHAPTER 6

#### SOLID STRIP FLOOR

**TONGUE AND GROOVE**  
1 1/2", 2", 2 1/4", 3", 3 1/4", Widths  
1/2", 3/4", 33/32", thick classification  
3/8", 5/16", thin classification

**SQUARE EDGE, Unfinished**  
5/16"X1 1/3", 1 1/2", 2", thin classification

I. Minimum Acceptable Jobsite Conditions and Checklist See Section 1

#### II. Acclimation Guidelines

NOTE: Always follow the manufacturer's recommendation for acclimation.

Upon delivery check wood flooring moisture content (Section V, Appendix AB, AD and AE) to establish a baseline for required acclimation (Section 1, Chapter 1).

Acclimation depends on geographic location, interior climate control and time of year. See Definition of Acclimation under Section VI. Refer to Section V, Appendix AD and AE.

#### III. Subfloor Grade Levels (Section V, Appendix AF)

Above Grade: Solid strip wood floors can be installed successfully above grade level.

On Grade: Solid strip wood floors can be installed successfully on grade level.

Below Grade: SOLID WOOD FLOORS ARE NOT RECOMMENDED FOR BELOW GRADE INSTALLATIONS.

**NOTE: The entire flooring level is considered to be BELOW grade where soil is present along any perimeter wall and is more than 3" above the installed wood flooring level. Ground should be sloped away from the house for proper drainage. Check local building codes. Local building codes prevail. Follow local building codes.**

## Chapter 6, Solid Strip Floor

### IV. Subfloor Guidelines – Wood Joist Systems – panel products or solid boards

**NOTE:** Always follow the manufacturers recommendation for proper subfloor

**NOTE:** Subfloor/Underlayment panels should conform to the US Voluntary Product Standard PS 2-92 or PS 1-95 and/or Canadian performance standard CAN/CSA 0325.0-92 Construction Sheathing. Check underside of boards for codes.

**NOTE:** Solid board subflooring should be: 3/4" x 5 1/2", Group 1 dense softwoods, (SYP, Doug Fir, Larch, etc), No. 2 Common, Kiln dried less than 15% MC.

Check subfloor for performance stamp and/or specification agency.

Subfloor must be flat, clean, dry, structurally sound and free of squeaks and free of protruding fasteners.

Test subflooring for moisture according to Moisture Testing Procedures in Section V, Appendix AB. Moisture content should be within 4% of average area environmental conditions. Section V, Appendix AD and AE.

For installations using mechanical fasteners of 1-1/2" and above, the subfloor should be flat to within 1/4" in 10' or 3/16" in 6'.

For gluedown installations and installations using mechanical fasteners of less than 1-1/2", the subfloor should be flat to within 3/16" in 10' or 1/8" in 6'.

For paneled subflooring/underlayment – nailing schedule must be adequate, typical-every 6" along panel ends and every 12" along intermediate supports; all panel edges should exhibit spacing; edge swell should be flattened as necessary.

For board subflooring – Boards should be no wider than 6"; installed at 45 degree angle with all board ends full bearing on joists and nailed with 2, 8d nails; 1/4"-1/2" space should be present between board edges.

**NOTE:** Thick classification flooring can be installed directly over board subflooring. Thin classification flooring must have a minimum 1/4" plywood underlayment installed over the board subflooring.

Thick classification-

PREFERRED SUBFLOORING: 3/4" (23/32", 18.3mm) CDX Plywood subfloor/underlayment (Exposure 1), 4' X 8' sheets; OR 3/4" (23/32", 18.3mm) OSB subfloor/underlayment, with joist spacing 19.2" (475mm) on center or less.

MINIMUM: 5/8" (19/32", 15.1mm) CDX Plywood subfloor/underlayment (Exposure 1) 4' X 8' sheets, maximum 16" (400mm) on center joist construction.

## Chapter 6, Solid Strip Floor

Thin classification-

MINIMUM SUBFLOORING: 3/4" (23/32", 18.3mm) CDX Plywood subfloor/underlayment (Exposure 1), 4' X 8' sheets; OR 3/4" (23/32", 18.3mm) OSB subfloor/underlayment, with joist spacing 19.2" (475mm) on center or less.

Follow panel manufacturer recommendations for spacing and fastening. Typical panel spacing and fastening for joist systems, 1/8" (3.2mm) around perimeter and fastened every 6" (150mm) on bearing edges and every 12" (300 mm) along intermediate supports.

**NOTE: With minimum specified materials, at maximum span and spacing (i.e. greater than 19.2") plank flooring will exhibit minimum performance. Minimum performance may result in the following conditions: movement, gaps, noises, and with site finished flooring finish delamination.**

For 3/4" (18.3mm) CDX Plywood and 23/32" (18.3mm) OSB, with joist systems spaced over maximum 19.2" (475mm) o/c requires an additional layer of plywood is required. Minimum requirement; 1/2" (15/32", 11.9mm) CDX plywood subfloor/underlayment, (Exposure 1) 4'X8' sheets. The 1/2" plywood should be offset by 1/2 panel in each direction to the existing subflooring. The panels may also be laid on a diagonal or perpendicular, with 1/8" spacing between sheets. Nail on a 6" minimum grid pattern-using ring shanked nails. Or brace between joists with 2X6 or wider boards every 24".

### V. Subfloor Guidelines – Concrete Slab

**NOTE: Always follow the manufacturers recommendation for proper subfloor**

Concrete must be flat, dry, structurally sound and clean.

**NOTE: A moisture retarder with permeance equivalent to 4-mil polyethylene film is always required over the concrete slab and below the subflooring material.**

Test concrete for moisture according to Moisture Testing Procedures in Section V, Appendix AA. Excess moisture should not be present.

Tolerance should be flat to within 3/16" in 10' or 1/8" in 6'.

For installations using mechanical fasteners of 1-1/2" and above, the subfloor should be flat to within 1/4" in 10' or 3/16" in 6'.

Substrate should be flattened to tolerance.

Lightweight concrete (less than 3000 psi) where adhesive used has a higher psi rating than concrete, use with a Subfloor-Floated.

## Chapter 6, Solid Strip Floor

RULE OF THUMB: Draw a nail across the top and if it leaves an indentation, it is probably lightweight concrete, use Subfloor-Floated.

**Before moisture testing begins, the slab must be cured for a MINIMUM of 30 days.**

NAIL DOWN STRIP FLOORING MUST HAVE AN APPROVED SUBFLOOR OVER THE CONCRETE. STRIP CANNOT BE SHOT TO THE CONCRETE. 3/4" STRIP CANNOT BE DIRECT GLUED TO CONCRETE.

SOME MANUFACTURERS SUGGEST DIRECT GLUE TO CONCRETE INSTALLATION OF 3/4" SOLID STRIP IN LENGTHS OF LESS THAN 11 1/4" and 1/2" THICK AND THINNER SOLID STRIP FLOORING REGARDLESS OF LENGTH. IN SUCH CASES, FOLLOW MANUFACTURERS RECOMMENDATIONS.

### Subfloor – Floated

**NOTE: Always follow the manufacturers recommendation for proper subfloor**

Add moisture barrier before applying underlayment. (Section V, Appendix AG)

PREFERRED Subfloor system: 2 layers 1/2" (15/32", 11.9mm) CDX Plywood subfloor/underlayment (Exposure 1), 4'X 8' sheets. MINIMUM Subfloor system: 2 layers 3/8" (10mm) CDX plywood subfloor/underlayment, (Exposure 1), 4'x8' sheets.

Place first plywood layer with edges parallel to wall, without fastening.

Plywood should be placed with 1/8" gaps between sheets

Lay second layer perpendicular or at 45 degree angle to first

Plywood should be placed with 1/8" gaps between sheets 3/4" minimum expansion space at all vertical obstructions and wall lines Staple, screw, or nail second layer to first layer on 12" grid pattern.

ALTERNATE Subfloor: 3/4" (23/32", 18.3mm) CDX Plywood sheathing, (Exposure 1), 4'x8' sheets; cut to 16"X8' planks, scored on back 3/8" deep every 12" across width, 16" planks oriented perpendicular to direction of flooring, panels staggered every 2", and spaced 1/8" between ends and 1/4" to 3/4" between edges.

3/4" minimum expansion space at all vertical obstructions.

### Glue Down Subfloor

**NOTE: Always follow the manufacturers recommendation for proper subfloor**

Add moisture barrier before applying underlayment. (Section V, Appendix AG)

## Chapter 6, Solid Strip Floor

Thick classification-

Subfloor: 3/4" (23/32), 18.3mm) CDX Plywood sheathing, (Exposure 1), 4'x8' sheets.

For single layer system; Apply adhesive per manufacturers recommendations (typical spread rate – 30-35 sq.ft.per gallon with a 1/4" x 1/4" notched trowel), cut plywood to 16"X8' planks, or 2'x8' sections or 4'x4' sections, scored on back 3/8" deep (scoring for 16" planks every 12" across width, for 2' and 4' sections on a 12"X12" grid). 16" planks and 2' sections oriented perpendicular to direction of flooring, panels staggered every 2', and spaced 1/8" between ends and 1/4" to 3/4" between edges. Space 4'x4' sections 1/8" to 1/4"

Thin classification, tongue and groove – including 1/2" thick flooring.

MINIMUM SUBFLOORING: 5/8" (19/32", 15.1mm) CDX Plywood sheathing, Exposure 1, 4'X8' sheets.

For single layer system: Apply adhesive per manufacturers recommendations (typical spread rate- 30-35 sq. ft. per gallon with a 1/4" X 1/4" notched trowel), cut plywood to 16"X8' planks, or 2'x8' sections or 4'x4' sections, scored on back 5/16" deep (scoring—for 16" planks every 12" across width, for 2' and 4' section on a 12" X 12" grid). 16" planks and 2' sections oriented perpendicular to direction of flooring, panel staggered every 2' and spaced 1/8" between ends and 1/4" to 3/4" between edges. Space 4'X4' sections 1/8" to 1/4".

1/2" minimum expansion space at all vertical obstructions.

### Nail Down Subfloor

**NOTE: Always follow the manufacturers recommendation for proper subfloor**

Add moisture barrier before applying underlayment.

Thick classification-

PREFERRED Subfloor system: 3/4" (23/32", 18.3mm) CDX Plywood subfloor/underlayment, (Exposure 1), 4'X8' sheets.

Use full 4'x8' sheets or cut to 16"X8' planks, or 2'x8' sections. Full sheets oriented at 45 degrees (preferred) or perpendicular to direction of flooring. 16" planks and 2' sections oriented perpendicular to direction of flooring staggered every 2'. Space 1/8" between ends and 1/4" to 3/4" between panel edges. Staggered joints, full sheets by 1/2 sheet, for planks and sections by 2'.

Fasten every 12" and 6" from edge along the border for a minimum of 32 shots per 4'x8" sheet.

## Chapter 6, Solid Strip Floor

For 2' sections and 16" planks fasten every 12" along the length with 1 or 2 fasteners equally spaced from edges.

3/4" minimum expansion space at all vertical obstructions

Thin classification, tongue and groove-including 1/2" thick flooring.

MINIMUM SUBFLOORING: 5/8" (19/32", 15.1mm) CDX Plywood sheathing, (Exposure 1), 4'x8' sheets.

Use full 4'x8' sheets or cut to 16"X8' planks, or 2'x8' sections. Full sheets oriented at 45 degrees (preferred) or perpendicular to direction of flooring. 16" planks and 2' sections oriented perpendicular to direction of flooring staggered every 2'. Space 1/8" between ends and 1/4" to 3/4" between panel edges. Staggered joints, full sheets by 1/2 sheet, for planks and sections by 2'.

Fasten every 12" and 6" from edge along the border for a minimum of 32 shots per 4'x8" sheet.

For 2' sections and 16" planks fasten every 12" along the length with 1 or 2 fasteners equally spaced from edges.

1/2" minimum expansion space at all vertical obstructions

**NOTE: Fasteners may be powder driven pins, pneumatic driven nails, hand nails, screws, deformed pins, or other fasteners suitable for concrete application. Check with fastener distributor for specification such as length, drill size, and/or shot load where applicable.**

### Screed System

**NOTE: Only 3/4" and 33/32" tongue and groove strip flooring may be installed directly to screeds.**

Screeds. 2"X 4" or 2"X 3" Group 1 species, pressure treated, kiln dried after treatment to 12% m.c. or less should be flat with minimum twist or crook, cut as necessary to maintain flatness, 18" - 48" long.

Thin classification, tongue and groove – including 1/2" thick flooring.

For screed runs spaced maximum 16" on center and 1/2" and thinner flooring a subfloor is required. Screed should be at right angles to direction of finished floor. MINIMUM SUBFLOORING: 5/8" (19/32", 15.1mm) CDX Plywood sheathing, (Exposure 1), 4'x8' sheets. Set screeds with widest dimension in rivers of adhesive for 100% contact, space 1/8" at end joints, screed joints should be staggered and not fall directly under subfloor panel edges.

## Chapter 6, Solid Strip Floor

Use cold bond adhesive or adhesive approved by the manufacturer

Lay screed runs maximum 12" on center at right angles to direction of finished floor, leaving 3/4" expansion at all vertical obstructions. For flooring grades averaging less than 2 1/2' long screed run spacing maximum 9" on center, leaving 3/4" expansion at all vertical obstruction.

Lay 6-8 mil poly film over screeds

1/2" minimum expansion space at all vertical obstructions.

### VI. INSTALLATION (Tongue and Groove Flooring)

**NOTE: Always follow the manufacturers recommended installation procedure.**

Unfinished/Factory finished solid plank should be installed perpendicular to the joists or on a diagonal for any single layer subfloor. (exception, diagonal, solid sub-floor boards, install perpendicular to joist or subfloor direction).

CAUTION: When laying 1/2", 3/4" and 33/32" solid plank flooring parallel with the floor joists either add an additional layer of minimum 1/2" (15/32") CDX plywood underlayment to the existing subfloor (as previously recommended) to the existing subfloor or brace between joists with 2" X 6" or wider boards every 24" minimum.

**NOTE: Do not lay thin classification flooring parallel to joists.**

Subfloor must be within 4% moisture content of the hardwood floor before installing. Refer to Section V, Appendix AB.

Before installing wood flooring place #15 lb. asphalt saturated felt paper that meets ASTM Standard D4869 or use a building paper with an equivalent permeance over wood subfloor. REFER TO MANUFACTURERS RECOMMENDATION BEFORE PROCEEDING.

Snap a working line parallel to the starting wall allowing 3/4" expansion space (Expansion space will typically equal the thickness of the flooring installed.) between the starting wall and the edge of the first plank run.

A 3/4" expansion space must be left around the perimeter and at all vertical obstructions.

Lay one row of strip along the entire length of the working line.

## Chapter 6, Solid Strip Floor

Top and blind nail the first row (hand nail if necessary), using appropriate fasteners. Each succeeding row should be blind nailed with the nailing machine wherever possible. At the finishing wall and other obstructions, it may be necessary to blind nail by hand until top nailing is required.

Racking rule of thumb: Stagger end joint a minimum of 6" between pieces on adjacent rows, see figure 1-1. Avoid H joints

Add each additional row of flooring, watching the pattern repeat and offsetting or staggering the end joints at least 6 inches.

On floors wider than 20' to minimize expansion: More or less spacing may be needed depending on geographical area, interior climate control and time of the year.. In some areas, additional spacing may not be necessary.

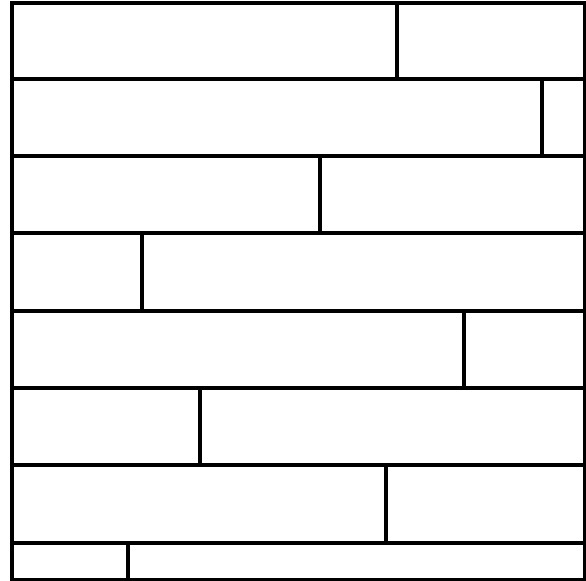

Figure 1-1 ACCEPTABLE

Where spacing is required: Use a washer or removable spacer to leave additional space every few rows and/or start in center of room and work out to both sides.

Nailing: Blind nail through the tongue using 2" barbed flooring cleat, 7d or 8d flooring nail, or 2" (15 gauge) staples with 1/2" crown. Use 1 1/2" length, fasteners with 3/4" plywood subfloor direct to concrete slab. Face nail boards where needed using 7d or 8d flooring nail – casing nail – galvanized nail – finishing nail, or flooring cleat. Fasteners should be spaced every 8".

Blind nail and face nail, as necessary, to complete the final rows.

### VII. INSTALLATION (Square Edge Thin Flooring)

**NOTE: Always follow the manufacturers recommended installation procedure.**

Unfinished solid square edge strip flooring should be installed perpendicular to the joists or on a diagonal for any single layer subfloor.

Subfloor must be within 4% moisture content of the properly acclimated wood floor before installing. Refer to Section V, Appendix AB.

**NOTE: Do not use asphalt products under square edge flooring.**



## Chapter 6, Solid Strip Floor

Snap a working line parallel to the starting wall allowing 5/16" expansion space between the starting wall and the edge of the first strip run.

A 5/16" expansion space must be left around the perimeter and all vertical obstructions.

Lay one row of strip along the entire length of the working line.

Top nail the first row (hand nail, if necessary), using the appropriate fasteners as recommended by the manufacturer. Nailing should be 2 nails every 7" along the length of the strip for 1 1/2", and 2" flooring. For 1 1/3" flooring, 1 nail every 5". Each succeeding row should be top nailed with the nailing machine. (Do not use an air operated finish nailer for nailing) Set all nails.

Racking rule of thumb: Stagger end joint a minimum of 6" between pieces on adjacent rows, see figure 1-1. Avoid H joints.

Add each additional row of flooring offsetting or staggering the end joints at least 6 inches.

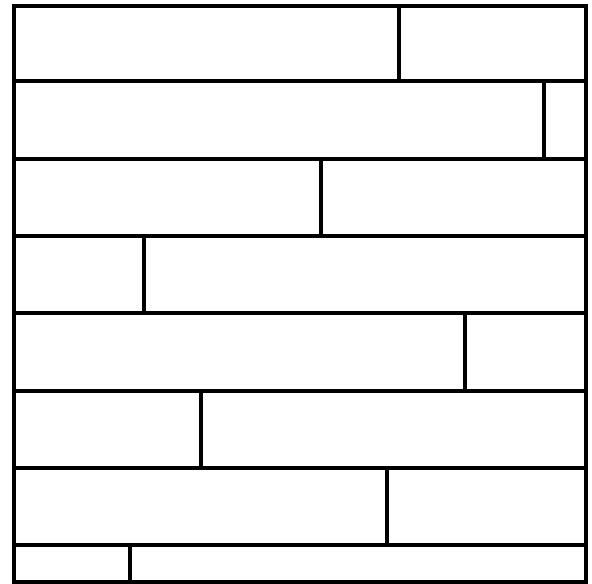

Figure 1-1 ACCEPTABLE

### VII. EXISTING FLOORING GUIDELINES

**NOTE: Always follow the manufacturer's recommendations for installation over existing flooring.**

Check existing flooring for soundness and repair and refasten as necessary.

Wood flooring can be nailed directly into existing sheet vinyl or vinyl tile if the sub-floor is within NWFA guidelines (5/8" 19/32") or thicker CDX grade plywood underlayment or 3/4" (23/32") or thicker OSB underlayment. (Particleboard is not an acceptable underlayment.)

Wood flooring can be nailed to existing flat, dry and structurally sound solid strip or plank wood floors by sanding high spots and laying the floor at a 45 to 90 degree angle to the existing wood floor. Adding an additional 1/2" underlayment (minimum 3/8") allows for the floor to be installed in any direction.

Wood flooring can be installed over existing ceramic tile, terrazzo, or marble with proper underlayment only on manufacturers recommendation.

# **S E C T I O N   I I I**

## **SPECIAL INSTALLATION REQUIREMENTS**

<b>Chapter 7</b>	<b>Wood Joists - Deflection Factor</b>	<b>Page 1</b>
<b>Chapter 8</b>	<b>Radiant Heat Installation</b>	<b>Page 3</b>
<b>Chapter 9</b>	<b>Sound Control Products</b>	<b>Page 11</b>
<b>Chapter 10</b>	<b>Trims &amp; Thresholds</b>	<b>Page 13</b>

# SECTION III

## SPECIAL INSTALLATION REQUIREMENTS

### CHAPTER 7

#### WOOD JOISTS - DEFLECTION FACTOR

Wood Joists include joists, I joists and dimensional sawn lumber

With current construction specifications, NWFA, in conjunction with the American Plywood Association, have determined the following underlayment requirement based on spacing of supports.

3/4" CDX Plywood and 23/32" OSB can be used singly up to 19.2" o.c. spacing. 7/8" CDX Plywood or OSB can be used singly up to 24" o.c. spacing. Here are the APA recommendations with which NWFA concurs. Refer to Table 1.

With 3/4" CDX Plywood or 23/32" OSB, if the truss system is more than 19.2" o.c., you must overlay with 1/2" CDX Plywood cross directed or brace between joists with 2X4 or wider boards every 24".

With 5/8" CDX Plywood underlayment, if the truss system is more than 16" o.c., you must overlay with 1/2" CDX Plywood cross-directed or brace between joists with 2X4 or wider boards every 16".

TABLE 1 Subfloors and Spacing of Floor Framing for Hardwood Flooring

Minimum Thickness	Code Plus Maximum Spacing
5/8" Plywood	16" o.c.
3/4" Plywood	19.2" o.c.
23/32" OSB	19.2" o.c.
7/8" Plywood	24" o.c.

## Chapter 7, Wood Joist - Deflection Factor

### DEFLECTION IN RESIDENTIAL FLOORS

For long-span residential floors framed with sawn joists, wood I-joists or trusses a simple deflection design rule of thumb is proposed that in most cases should yield a floor with satisfactory performance from a vibration standpoint. The proposed rule of thumb<sup>1</sup> limits deflection under live load to  $L/360$  for members spanning up to 15 feet and to  $L/480$  for members spanning 15 to 30 feet. Both equations equal a deflection of approximately 1/2-inch.

The reference on the subject of residential floor vibration is "Minimum Property Standards for One and Two Living Units" which defines the minimum construction standards that must be met in order to qualify for a FHA mortgage.

Design deflection of structural members when subjected to total loads of live loads specified herein plus actual dead loads shall not exceed the following:

Floor joists, beams and girders, and ridge beams supporting roof joists,  $L/360$  of the clear span of the member up to 15 feet. Over 15 feet, deflection shall not exceed 1/2 inch.

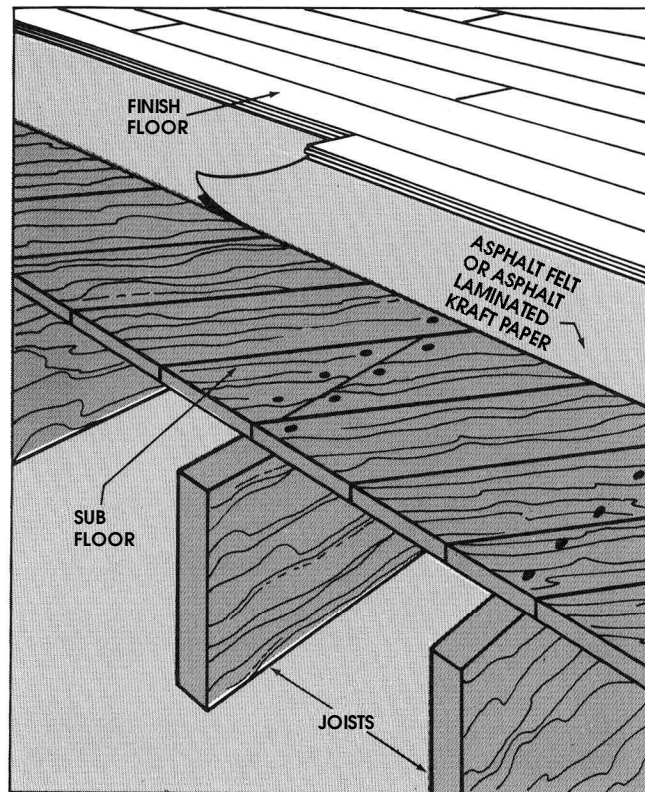

(Illustration courtesy of NOFMA)

figure 1-1

<sup>1</sup> "A Proposed Rule of Thumb for Controlling Annoying Vibrations in Residential Floors" by Frank E. Woeste, Ph.D., P.E., Virginia Tech.

# SECTION III

## SPECIAL INSTALLATION REQUIREMENTS

### CHAPTER 8

#### RADIANT HEAT INSTALLATIONS

With radiant heat, the heat source is directly beneath the flooring, so the flooring may dry out faster than a similar floor in a home with a conventional heating system. Wood flooring can be installed over radiant heat as long as you understand radiant heat and how it can impact wood flooring, what precautions to take, and what type of wood flooring to use.

Types of wood flooring that are best suited for radiant heat subfloor are products that possess improved dimensional stability such as:

Engineered Wood Flooring - is more dimensionally stable than solid wood flooring.

Certain Species are known for their inherent dimensional stability such as American cherry, American walnut, teak and others. Other species such as maple and Brazilian cherry are less stable.

Quartersawn and Rift Sawn Wood Flooring - is more dimensionally stable in width than plain sawn wood flooring.

Narrow boards are more dimensionally stable than wider boards. Solid plank wood flooring 4 inches and wider is not recommended over radiant heat.

#### GENERAL RADIANT HEAT INSTALLATION GUIDELINES

To minimize the effect that rapid changes in temperature will have on the moisture content of the wood floor, it is recommended that an outside thermostat be installed. If one is not present, suggest to your customer that this should be considered. Unlike conventional heating systems whereby when it becomes cold, the heat is switched on, the radiant systems work most effectively and with less trauma to the wood floor if the heating process is gradual, based on small increment-increases in relation to the outside temperature.

Subfloors should have proper moisture tests according to Moisture Test Procedure in Section V, AA and AB. Refer to Section V, AD and AE.

## Chapter 8, Radiant Heat Installation

The essential requirement in proper applications of wood flooring over radiant heated systems is to avoid penetration of the heating element. Radiant heated subfloor systems can be concrete, wood or a combination of both. The type of subfloor as described in the previous chapters determines subfloor preparation.

If the subfloor is concrete and it has cured, turn the heat on, regardless of season, and leave it on for at least 5-6 days before installation of the wood flooring to drive out residual moisture. Some installation systems, particularly glue down applications, require the heat to be reduced or even turned off before installation of the flooring begins.

With water heated radiant systems a pressure test must be performed by a qualified plumber or the system installer prior to beginning the installation of the wood flooring. The following installation and subfloors systems can be used successfully over radiant heat:

1. Glue down, engineered or solid parquet
2. Direct nail, solid wood or engineered wood flooring to wood subfloor
3. Solid T & G floor direct nail to sleepers
4. Single layer of plywood on sleepers
5. Double plywood floating subfloor
6. Floating engineered
7. Loose lay single layer of cdx plywood cut in 16" planks staggered, with 1/8" gap between laid perpendicular to wood direction.

NOTE: Follow manufacturers' printed installation instructions.

## Chapter 8, Radiant Heat Installation

### GLUE DOWN ENGINEERED OR SOLID PARQUET

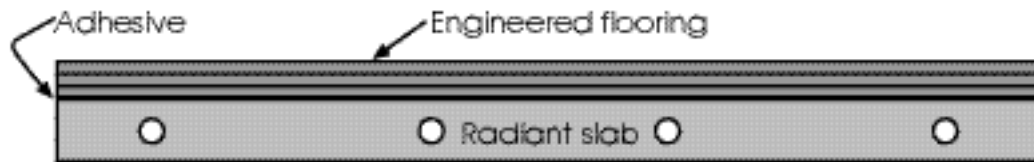

Install over approved subfloor - refer to Section II, Engineered Floor or Section II, Solid Parquet Floor.

Can be glued direct to approved subfloor. Always check for subfloor moisture. See Appendix AA.

The heating system has to be turned off before installation.

Use adhesive approved by the manufacturer.

Maximum surface temperature - 85 degrees F (29.44 degrees C).

Expect some heating season shrinkage.

NOTE: Follow manufacturers' printed installation instructions.

## Chapter 8, Radiant Heat Installation

### DIRECT NAIL, SOLID WOOD OR ENGINEERED TO WOOD SUBFLOOR

Must have an NWFA approved subfloor for wood flooring. (Refer to Section II, CHAPTER 4-6.

Always check for subfloor moisture. See Appendix AB.

Solid wood must be properly acclimated to normal living conditions.

Be sure nails are not so long as to penetrate heating elements.

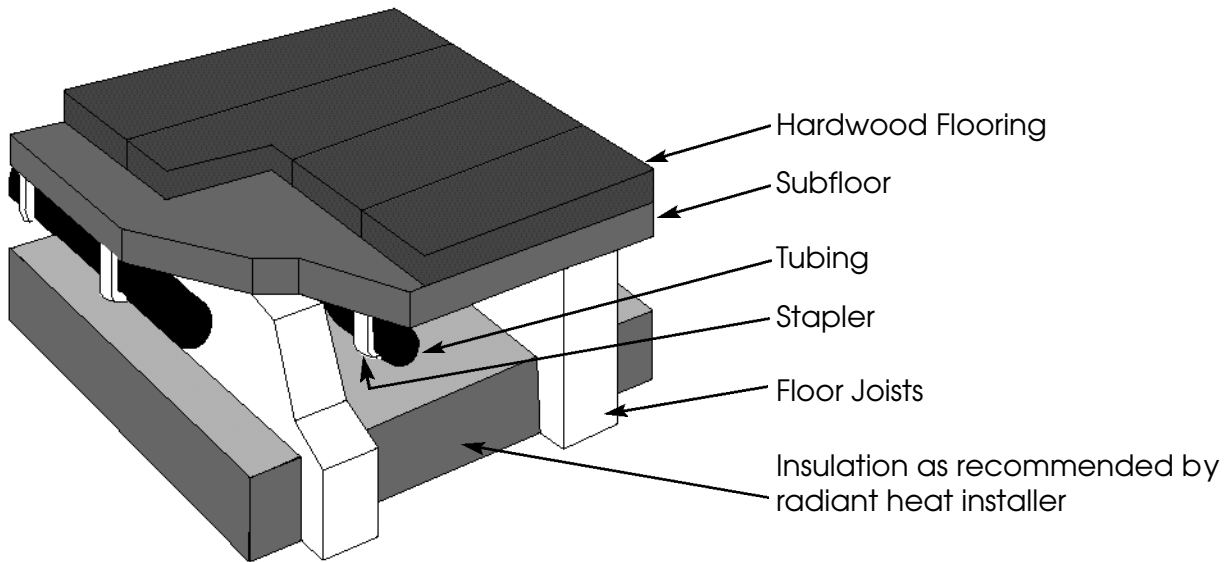

All other installation procedures are the same as outlined in Section II, Chapter 4-6.

Maximum surface temperature - 85 degrees F (29.44 degrees C).

Expect some heating season shrinkage.

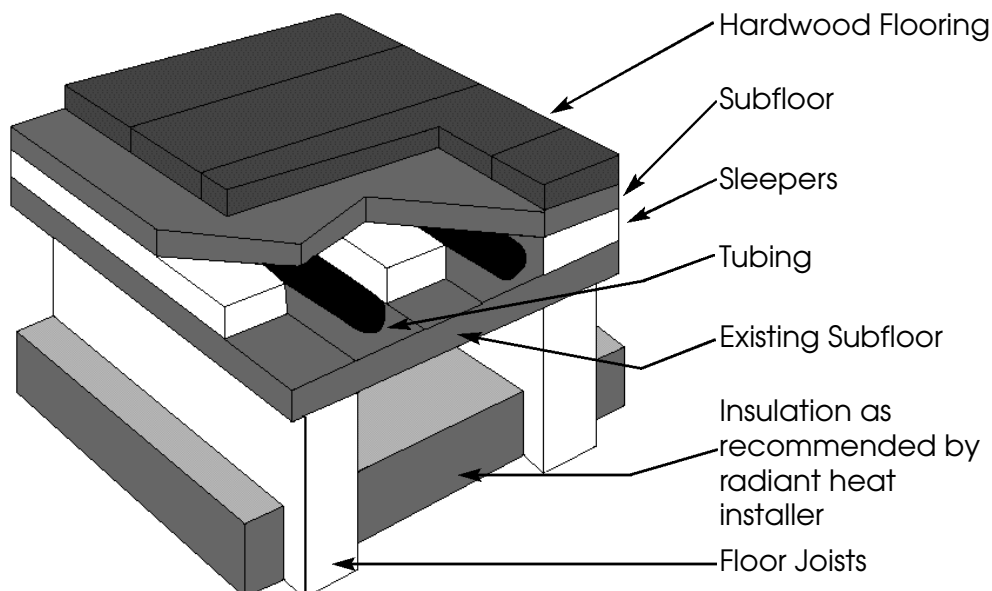

NOTE: Follow manufacturers' printed installation instructions.



## Chapter 8, Radiant Heat Installation

### SOLID T & G FLOOR DIRECT TO SLEEPER

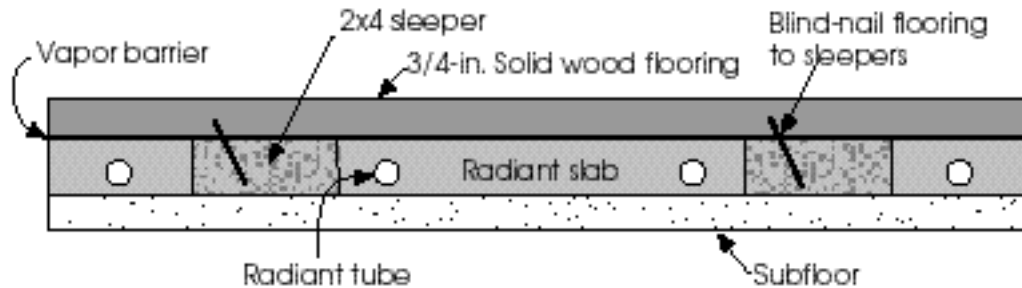

Must follow the installation guidelines for installation over screed systems as outlined in Section II, Chapter 5-6.

If over suspended subfloor, a vapor retarder may not be necessary.

The use of solid plank 4 inches and wider is not recommended over radiant heated systems.

Solid wood must be properly acclimated.

Cannot use shorts.

Maximum surface temperature - 85 degrees F (29.44 degrees C).

Expect some heating season shrinkage.

NOTE: Follow manufacturers' printed installation instructions.

## Chapter 8, Radiant Heat Installation

### SINGLE LAYER OF PLYWOOD ON SLEEPER

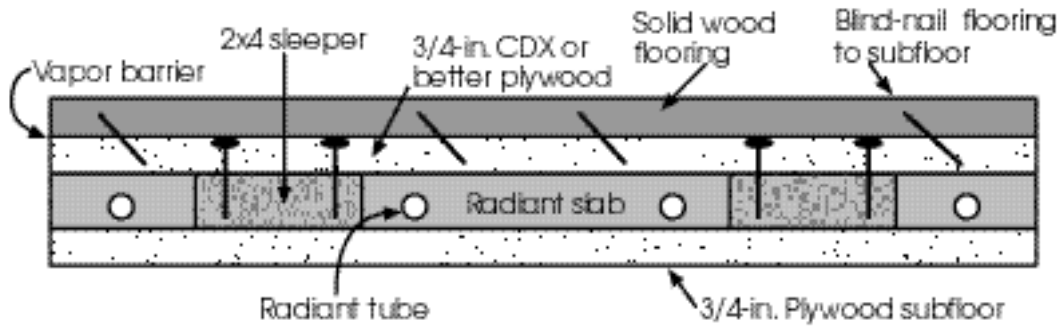

Must follow the installation guidelines for installation of plywood on sleepers systems as outlined in Section II, Chapter 5-6.

If over suspended subfloor, a vapor retarder may not be necessary.

The use of solid plank 4 inches and wider is not recommended over radiant heated systems.

Solid wood must be properly acclimated.

Maximum surface temperature - 85 degrees F (29.44 degrees C).

Expect some heating season shrinkage.

NOTE: Follow manufacturers' printed installation instructions.

## Chapter 8, Radiant Heat Installation

### DOUBLE PLYWOOD

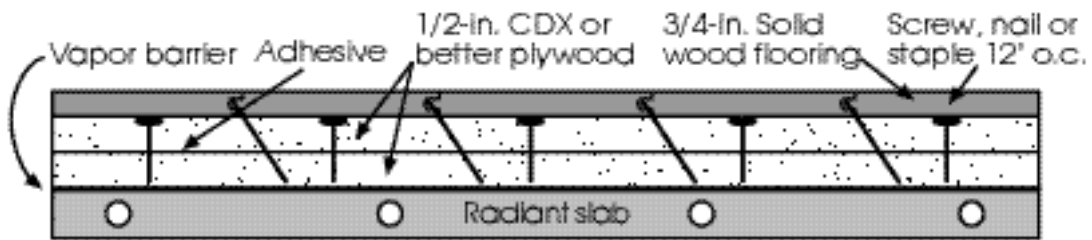

Must follow the installation guidelines for installation of floated subfloor as outlined in Section II, Chapter 3-6.

The use of solid plank 4 inches and wider is not recommended over radiant heated systems.

Solid wood must be properly acclimated.

Maximum surface temperature - 85 degrees F (29.44 degrees C).

Expect some heating season shrinkage.

NOTE: Follow manufacturers' printed installation instructions.

## Chapter 8, Radiant Heat Installation

### FLOATING ENGINEERED

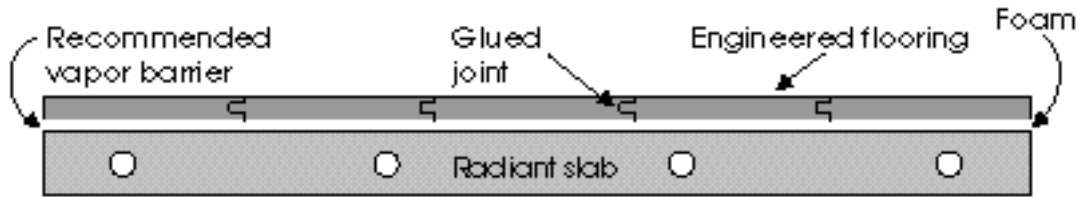

Install over approved subfloor. Refer to section II Engineered-Unfinished/Prefinished/Impregnated. Always check for subfloor moisture. See section AA.

A 6 mil or better polyethylene vapor barrier should be installed over concrete subfloors.

A recommended foam or resilient underlayment must be installed prior to application of the wood flooring.

Use an adhesive approved by the manufacturer for side and/or end joints.

Maximum surface temperature-85 degrees F (29.44 degrees C).

NOTE: Follow manufacturers' printed installation instructions.

# **SECTION III**

## **SPECIAL INSTALLATION REQUIREMENTS**

### **CHAPTER 9**

#### **SOUND CONTROL PRODUCTS**

The UBC Uniform Building Code and the BOCA National Building Code both have requirements regarding sound control for multi-family dwellings. Areas of the country which do not follow either of these code standards may have local building code regulations with their own sound control requirements.

The BOCA National Building Code, 1996 has the following section for sound control: "1214.2 Air-borne noise: Walls, partitions and floor/ceiling assemblies separating dwelling units from each other or from public or service areas shall have a sound transmission class (STC) of not less than 45 for air-borne noise when tested in accordance with ASTM E90 listed in Chapter 35. This requirement shall not apply to dwelling unit entrance doors; however, such doors shall be tight fitting to the frame and sill. 1214.3 Structure borne sound: Floor/ceiling assemblies between dwelling units or between a dwelling unit and a public or service area within the structure shall have an impact insulation class (IIC) rating of not less than 45 when tested in accordance with ASTM E492 listed in Chapter 35."

Condominium associations may have a set of protective covenants with even more stringent regulations than the Uniform or National Building Code.

Sound rating values measure the amount of sound that is transmitted from room to room. The values are determined by the reduction of noise as attributed to the barrier elements.

Sound striking a wall or ceiling surface is transmitted through the air in the wall or ceiling cavity. It then strikes the opposite surface, causing it to vibrate and transmit the sound into the adjoining room. Sound is also transmitted through any openings into the room, such as air ducts, electrical outlets, window openings, and doors. This is air-borne sound transmission.

Sound Transmission Class (STC) measures the reduction of air-borne noise within a room such as music from a stereo.

Impact Insulation Class (IIC) measures the transmission of noise caused by impact to the floor.

The control of sound is achieved by separating the wood floor system from the building

## Chapter 9, Sound Control Products

with the use of Sound Control materials.

### Sound control materials:

6mm or thicker acoustical cork material applied to subfloor or underlayment with an adhesive approved by the manufacturer.

Sound deadening boards applied with an adhesive approved by the manufacturer.

1/16" to 1/4" closed cell foam, loose laid under an NWFA recommended floating subfloor system.

Sound Control Matting, loose laid under an NWFA recommended floating subfloor system.

Acoustical backed wood flooring.

NOTE: Always follow the wood flooring manufacturers recommended procedure.

NOTE1: Consult the manufacturer of the sound control material desired to determine the method of construction to meet minimum sound rating values of the project.

CAUTION: To maintain the integrity of sound control, do not use nails so that they penetrate the sound control material. If you use nails, the impact will travel through the nail to the surface below negating the effectiveness of the sound control system. The flooring must not contact walls, posts or other fixtures that may transmit noise to the rest or to another part of the building or surface.

# SECTION III

## SPECIAL INSTALLATION REQUIREMENTS

### CHAPTER 10

#### TRIMS & THRESHOLDS

##### MOLDINGS USED WITH HARDWOOD FLOORS



Baseboard

Wood floors require expansion space at the wall and all vertical obstructions. Moldings are used to cover the expansion area, to hide cut ends, to adjust height differences or transitions between floors and to aesthetically finish the area. Profiles are many and vary through the industry. Here are some examples of standard profiles.

BASEBOARD — from 3/8" and thicker, from 1 1/2" to 4+" high; used to protect the wall and cover expansion space.



Baseshoe

BASESHOE — from 3/8" to 5/8" thick, from 1/2" to 1" high; used instead of baseboard or with baseboard to complete expansion coverage; flexible enough to conform to irregular surfaces.



Quarter Round

QUARTER ROUND — one quarter of a full round; from 1/2" to 1"; used as an alternative to shoe in some areas.



Reducer

REDUCER — from 5/16" to 3/4" thick, 1" to 3"+ wide; used to make transition in thickness from wood floor down to thinner surface (or carpet or vice versa), generally through door openings. Also used to cover expansion space around vertical surfaces such as fireplace hearths when mounted directly to surface of flooring.

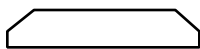

Threshold/Saddle

THRESHOLD/SADDLE — from 5/16" to 3/4" thick, many widths; used to make the transition at doorways, between interior rooms and to the outside. Can be custom milled to any size.

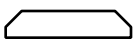

Baby Threshold

BABY THRESHOLD — Often variable - used to cover expansion space in perimeter areas where vertical molding cannot be used. Example: Stone, brick wall and hearths as well as floor to ceiling glass and sliding doors. May also be used at existing door thresholds.

## Chapter 10, Trims & Thresholds



T-Moldings

T-MOLDINGS — 5/8" thick by 2" wide, beveled down on both sides with a T-configuration; used for transition from one hard surface floor to another.

CUSTOM MOLDINGS — Specialty moldings created for unusual circumstances. May be manufactured to job site requirements to complement the wood floor and allow for proper transition and coverage of expansion space.

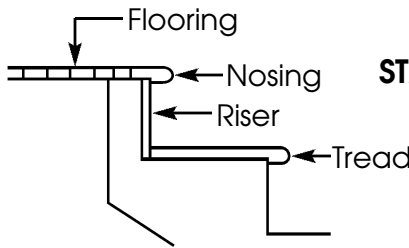

### STAIRS/STEPS

STAIR RISER — 3/4" thick, various heights and lengths, used to create the vertical "rise" in the step.

STAIR TREAD — 3/4" to 1 1/16" thick, various widths and lengths, the actual step surface.

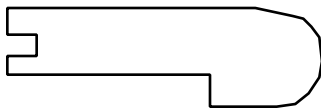

T-Moldings

NOSING — also called stair nosing, bull nose, stairwell trim, landing tread. Thickness same as flooring. Used to create finished edge on top step, around stairwell, sunken living room, etc.



## Chapter 2, Jobsite Checklist

If you see or suspect a product defect or unexpected problems:

- Stop all work
- Leave the premises

Use the nearest phone to contact your supplier, or if you're an employee, your office, before discussing your concern with the customer.

### THINGS TO DO:

Proper arrangements should have been made to move furniture, appliances, and/or disconnect gas or water. DO NOT ATTEMPT to disconnect any lines. Water and gas lines should be disconnected by the customer or proper utility company. DO NOT ATTEMPT to move furniture or appliances without adequate help and appropriate insurance coverage.

If not already noted, discuss any existing damage i.e. scratched walls, furniture, worn wallpaper, soiled or chipped paint with customer and make notes. If customer is not present - make a list or take photographs.

NOTE: If it appears that existing floor covering could contain asbestos, check with the appropriate authority for proper abatement procedures.

Make sure wood is properly acclimated. See Section VI, Glossary and Section V, Appendix AD and AE.

Upon completion, clean work area, including wood floor and properly dispose of all trash.

NOTE: Refer to the NWFA Jobsite Checklist form in Section V, Appendix EA.

# **S E C T I O N   I V**

## **JOBSITE FINISHING & REPAIR**

<b>Chapter 11 Bleaching</b>	<b>Page 1</b>
<b>Chapter 12 Finish types</b>	<b>Page 3</b>
<b>Chapter 13 Repair</b>	<b>Page 5</b>
<b>Chapter 14 Sand &amp; Finish - Strip &amp; Plank Solid Unfinished</b>	<b>Page 8</b>
<b>Chapter 15 Sand &amp; Finish - Strip &amp; Plank Solid Previously Finished</b>	<b>Page 12</b>
<b>Chapter 16 Sand &amp; Finish - Strip &amp; Plank Engineered Unfinished</b>	<b>Page 15</b>
<b>Chapter 17 Sand &amp; Finish - Strip &amp; Plank Engineered Previously Finished</b>	<b>Page 19</b>
<b>Chapter 18 Sand &amp; Finish - Parquet - Solid or Engineered - Unfinished</b>	<b>Page 23</b>
<b>Chapter 19 Sand &amp; Finish - Parquet - Solid or Engineered Previously Finished</b>	<b>Page 27</b>
<b>Chapter 20 Recoating Existing Surface Finished Floor</b>	<b>Page 30</b>

# SECTION IV

## JOBSITE FINISHING & REPAIR

### CHAPTER 11

#### BLEACHING

Bleaching wood flooring retains the general tone and reduces variations in color without obscuring the grain pattern.

Bleaching softens the surface fibers of the wood.

Bleaching a wood floor will change the existing color. It will not make the floor white. Red oak will lighten to a pink cast and white oak may have a greenish cast.

Make sure the flooring is clean and free from oils, grease and old finish.

Bleach may be caustic and can cause burns. Safety glasses and rubber gloves are always recommended.

Bleaching will cause the grain of the wood to raise.

Sanding with fine paper or buffing may be necessary after bleaching to restore flooring to a smooth surface. Refer to finish manufacturer's recommendation.

Most wood fillers cannot be bleached.

Use only bleach specified for wood flooring.

Follow the manufacturer's instructions for application. Some bleach may need to be neutralized.

Do a test area in an inconspicuous place as the length of time the bleach remains on the floor will affect the degree of color removal.

Do not do multiple applications. Subsequent applications soften the wood and make it prone to dent.

A white stain may be applied before the surface finish.

Always use non-ambering finishes with bleached/white floors and pastels.

Bleached wood must be allowed to dry completely and return to the correct moisture content before proceeding with finish application.

## Chapter 11, Bleaching

NOTE: Many manufacturers of stains and finishes recommend using a system, a series of products from the same manufacturer, to insure compatibility and best adherence. BEFORE USING DIFFERENT MANUFACTURERS FOR THE BLEACH, STAIN AND FINISH PRODUCTS, CHECK WITH THE MANUFACTURER FOR COMPATIBILITY.

# SECTION IV

## JOBSITE FINISHING & REPAIR

### CHAPTER 12

#### FINISH TYPES

##### OIL MODIFIED URETHANES

A petroleum base with a blend of synthetic resins, plasticizers and other film-forming ingredients produces a durable surface that is moisture-resistant. These finishes are available in different gloss levels.

##### WATER BASED URETHANES

A water base with a blend of synthetic resins, plasticizers and other film-forming ingredients produces a durable surface that is moisture-resistant. These finishes are available in different gloss levels.

NOTE: Cross linker should be for professional use only.

##### MOISTURE CURED URETHANE

These are harder and more moisture resistant than the other surface finishes. They cure by absorbing minute quantities of moisture from the air, which causes them to dry and harden. Relative humidity is critical to the curing process. Follow manufacturers directions. These finishes may be difficult to apply properly, and are best left to the professional.

##### CONVERSION VARNISH FINISHES (Swedish Finish)

Conversion varnish finishes which are products with durability and moisture resistance. These finishes may be difficult to apply properly and are best left to the professional.

##### PENETRATING SEALER

Sealers that are urethane or varnish-type materials that are, spread on the floor and allowed to penetrate. The excess is removed with rags or buffed in with steel wool or synthetic pads. These types of finishes may include a color and can be used to seal and stain the floor.

##### PASTE WAX

For surface protection, paste wax is spread in thin coats, generally following the application of a sealer and/or stain and then buffed.

## Chapter 12, Finish Types

### VARNISH

A product commonly used before the introduction of urethane finishes. Vinyl-alkyd varnishes have superseded natural varnish (made from vegetable oils).

### LACQUER

Lacquer is not recommended for use as a floor finish. Many manufacturers do not recommend using lacquer sealers, due to incompatibility and flammability.

### SHELLAC

Shellac is not recommended for use as a floor finish, but is used occasionally to match old finish. May be coated with wax.

NOTE: Inspection of finishes should be done from a standing position with normal lighting. Glare, particularly from large windows, magnifies any irregularity in the floors and should not determine acceptance.

# SECTION IV

## JOBSITE FINISHING & REPAIR

### CHAPTER 13

#### REPAIR

##### REPLACEMENT OF FLOOR BOARDS

Individual wood flooring boards can be repaired/replaced in solid, engineered and parquet products without affecting adjoining boards. Always check the species to insure a proper match,(i.e. red oak, white oak,etc).Prefinished boards should be selected for gloss and color match. Replacement boards do not necessarily have to be from original manufacturer as long as tongue and groove profile match as well as width, edge profile, cut and grade.

##### Removing the plank or strip on wood and concrete subfloors

Make sure you have a replacement board.

Set a circular saw to the depth of the thickness of the board to be removed.Make one cut inset 1/2" from groove side running from end to end on the board to be removed.

Make a second cut inset 1/2" from tongue side running from end to end on the board to be removed.

Make a third cut across the center of the board at a 30-45 degree angle from first long cut to second long cut.

With a chisel cut completely through both ends at cut lines and lift out center of the board. The groove side piece can now be easily removed.

Carefully remove nails or staples and side tongue piece. Avoid damage to adjoining boards.

Alternate method on wood and concrete subfloors.

Split board down the center and along the grain with chisel. Pry out pieces. Avoid damaging the adjoining boards.

Alternate method on wood and concrete subfloors.

Use a router to remove board being replaced. Avoid damaging adjoining boards.

## Chapter 13, Repairs

### Alternate method on wood subfloors only

Drill a series of large holes across center and against grain of board to be removed. Avoid drilling too far into subfloor.

Using a sharp chisel cut off the tongue of the board being replaced. Avoid damaging adjoining boards. Remove the board and trim the edges of the opening.

### Replacing flooring that has been nailed/stapled down

Clean all debris from the area.

Measure the opening and cut replacement board to size.

Carefully test the new board against the opening for precise fit.

From the back side of the replacement board, chisel off or cut lower half of its groove side and end match so that it will fit over the tongue of the adjoining boards in the replacement area.

Carefully dry fit the replacement board.

Coat tongue and groove with glue. If available, use a fast setting epoxy to coat the back of the board to avoid the use of nails (described below) in the repair.

Insert tongue, then drive it into place, using a wood block and mallet.

If adhesive has not been used to secure the board (as described above) to the subfloor drill pilot holes for nails at each end of board and along sides of long boards. Make holes smaller than the size of the cement coated nails. Sink nailheads with a nail set.

Use color putty to fill holes and joints. If unfinished, refinish to match original flooring.

### Replacing flooring that has been glued down.

Clean all debris and old adhesive from the work area. Repair subfloor if necessary.

Measure the opening and cut replacement board to size. Carefully test the new board against the opening for precise fit.



## Chapter 13, Repairs

From the back side of the replacement board, chisel off or cut lower half of its groove side and end match so that it will fit over the tongue of the adjoining board.

Dry fit the replacement board.

Coat tongue and groove with glue. Apply adhesive to the back of the board or to the subfloor. Use adhesive sparingly to prevent the unit from rising after replacement is complete.

Insert tongue, and then drive it into place, using a wood block and mallet. Use color putty to fill holes and joints. If unfinished refinish to match original flooring.

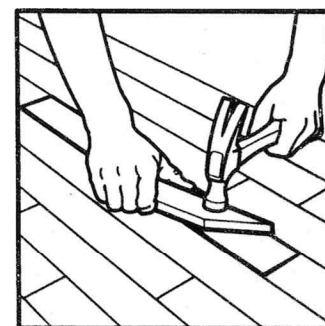
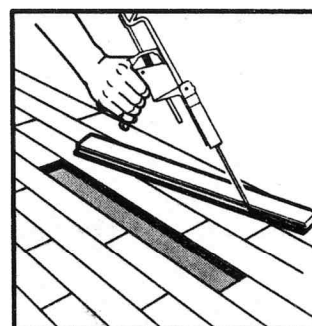
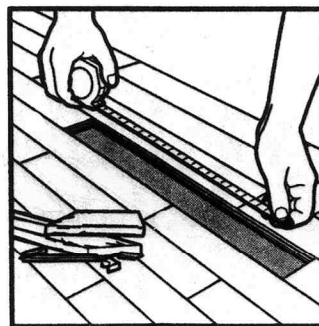
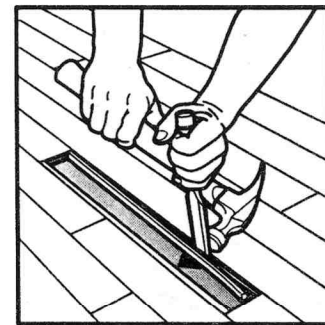
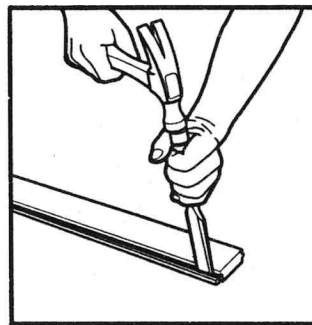
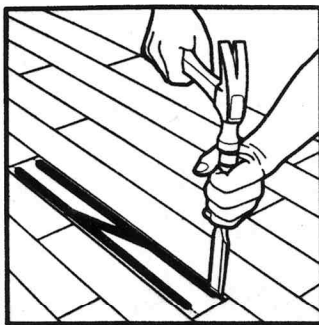
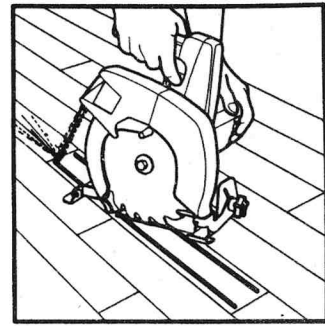
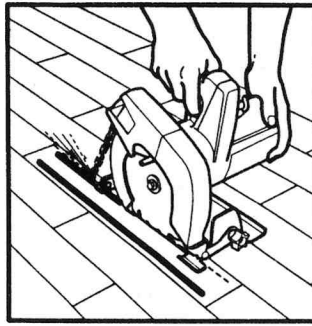
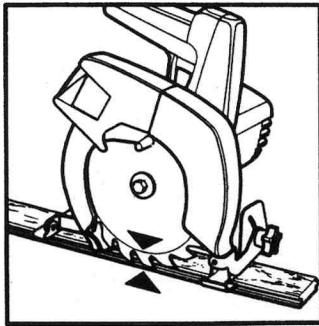

# SECTION IV

## JOBSITE FINISHING & REPAIR

### CHAPTER 14

#### SAND & FINISH - STRIP & PLANK SOLID UNFINISHED

Sanding and finishing should occur 1-3 weeks after installation.

Cover light fixtures. Warning, covered lights may be a potential fire hazard, these fixtures should remain off. Tape switch in off position if necessary.

Redecorating, such as wall-coverings and painting, should be completed and dry before refinishing the floor or wait until sanding is complete.

Sweep the floor clean before sanding and after every cut.

Inspect the floor carefully - look for protruding nail heads or staples. Set nails as necessary. Repair and replace all damaged boards.

Seal with plastic or appropriate dust blocker. Cover doorways, heat registers, returns, and windows in work area. Cover windows to keep out direct sunlight. Use the proper tape to hang plastic. NOTE: Some tape will damage paint and wall coverings.

#### Special Considerations Prior to Sanding:

Refer to manufacturer's recommendation for number of times the floor can be sanded and any other recommendations.

The number of sandings depends on the skill of the person sanding the floor, the type of equipment used, the thickness of the remaining wear-layer and the flatness of the floor.

Measure wear layer thickness in several areas and check for flatness to insure whether you should attempt sanding at all. Measurements can often be made at floor registers or by removing transition moldings.

NOTE: Appearance of bevels may not be consistent after sanding.

#### SANDING:

Load the professional sanding machine and edger with the proper sequence of sandpaper as shown in Section V, Appendix DC.

## Chapter 14, Sand & Finish - Strip & Plank Solid Unfinished



First cut is a coarse to medium grit.

Sand two thirds of the floor parallel to the grain.

When the two-thirds section is complete turn the sander in the opposite direction and repeat the process on the remaining third. Cuts made in the one-third area must overlap the first cuts by two to three feet to blend the two areas together. To avoid creating a trough be careful not to stop the sander in the exact same spot each pass by staggering the overlap every 2-3 passes.

After the first cut, sand edges and other places, inaccessible to the sanding machine, with an edger using the next sequenced sandpaper that will be used on the sanding machine. Move the edger in an easy semicircular pattern overlapping into the sanded area, cutting in the direction of the grain whenever possible.

Fill the floor after the first straight cut. Spot fill beveled edged products; square edged products may be spot or trowel filled.

Repeat the sanding procedure with a second cut using medium grit sandpaper.

Repeat edging procedure using the last sequenced grit as on the sanding machine.

Hand scrape corners, around door jambs or other areas where the edger cannot be used. Apply even pressure, scraping in the direction of the grain. After

## Chapter 14, Sand & Finish - Strip & Plank Solid Unfinished

scraping use a sanding block and paper (same grit as on sanding machine) to blend the flooring. Sanding the groove with the corner of the block may be necessary on bevel-edged products.

Repeat the sanding procedure using the final cut of fine sandpaper.

Use a buffer with a screen over the entire floor. On floors with chatter marks or waves, a hard plate should be used with the appropriate grit of sandpaper before screening.

NOTE: Never operate the sanding machine when the bag is over 1/2 full. Never leave the sanding machine with dust in the bag in your vehicle or on the job site.

### FINISHING

Inspect the floor carefully for all sanding errors. Repair all sander marks as necessary. After sanding is complete and all sander marks have been repaired, wipe or vacuum up all dust on baseboards, windows, sills, doors and door frames. Clean from the highest surface to the lowest, in that order. Use dampened cloth where appropriate on all surfaces except the bare wood floor.

Fill cracks and nail holes with commercial filler or putty that is compatible with stain and/or finish or make your own filler with dust from the final sanding mixed with a compatible mixing agent to form a thick paste. Apply with a putty knife and scrape off excess.

When dry, hand sand with fine paper.

Sweep or vacuum the floor clean. Repeat vacuuming until floor is clean.

If the floor is to be a natural finish apply sealer followed by the appropriate finish. If other than a natural color is desired the floor must be stained or bleached. For bleaching, refer to Section IV, Chapter 11.

NOTE: Many manufacturers of stains and finishes recommend using a system, a series of products from the same manufacturer, to insure compatibility and best adherence. BEFORE USING DIFFERENT MANUFACTURERS FOR THE STAIN AND FINISH PRODUCTS, CHECK WITH THE MANUFACTURER FOR COMPATIBILITY

Apply the stain according to manufacturer's coverage rate, application method and procedures. The length of time the stain is allowed to remain on the floor, the final sanding procedure and the species of the wood will determine the depth of color. Remove excess stain from within bevels.

## Chapter 14, Sand & Finish - Strip & Plank Solid Unfinished

Allow stain to dry thoroughly. Use manufacturer's recommended dry time. If the environment is excessively humid or cold, the stain may take longer to dry. The stain must be completely dry before finishing begins.

Burnish stain if required by manufacturer.

Apply sealer, if necessary according to manufacturer's recommended coverage rate, application method and procedures. Refer to the chart Section V, Appendix DA.

### OR

For a wax finish apply sealer, then wax and buff or burnish into wood.

### OR

For surface finishes, following intercoat abrasion, (see section V, Appendix DD) apply additional coats of finish according to manufacturer's recommendation.

Most surface finished floors can be walked on after 48 hours. Do not slide furniture on the floor, lift it into place after 48 hours or as recommended by the finish manufacturer. Area rugs can be put down after 14 days on water based finishes and 30 days for all other finishes or as recommended by the finish manufacturer.

Furniture or rugs placed too soon may result in finish or surface damage. Some area rugs and padding may damage or discolor the finish. This type of damage as well as color change due to aging and intense (UV) sunlight is not the responsibility of the flooring contractor.

# SECTION IV

## JOBSITE FINISHING & REPAIR

### CHAPTER 15

#### SAND & FINISH - STRIP AND PLANK SOLID PREVIOUSLY FINISHED

Remove all furniture, rugs and draperies from room.

Cover light fixtures. Warning, covered lights may be a potential fire hazard, these fixtures should remain off. Tape switch in off position if necessary.

Redecorating, such as wall-coverings and painting, should be completed and dry before refinishing the floor or wait until sanding is complete.

Remove the base shoe, quarter round or baseboards as needed.

Sweep the floor clean before sanding and after every cut.

Inspect the floor carefully - look for protruding nail heads or staples. Set nails as necessary. Repair and replace all damaged boards.

Seal with plastic or appropriate dust blocker. Cover doorways, heat registers, returns, and windows in work area. Cover windows to keep out direct sunlight. Use the proper tape to hang plastic. NOTE: Some tape will damage paint and wall coverings.

#### Special Considerations Prior To Sanding:

Refer to manufacturer's recommendation for number of times the floor can be sanded and any other recommendations.

The number of sandings depends on the skill of the person sanding the floor, the type of equipment used, the thickness of the remaining wear-layer and the flatness of the floor.

Measure wear layer thickness in several areas and check for flatness to insure whether you should attempt sanding at all. Measurements can often be made at floor registers or by removing transition moldings.

NOTE: Appearance of bevels may not be consistent after sanding.

## Chapter 15, Sand & Finish - Strip & Plank Solid Pr eviously Finished

### SANDING

Load the professional sanding machine and edger with the proper sequence of sandpaper as shown in Section V, Appendix DC.

Replace damaged boards prior to sanding. For badly damaged or cupped floors make the first one or two cuts at a 15 - 30 degree angle to smooth floor and remove all stain and finish.

The bevels of beveled edge flooring should be scraped and cleaned to remove finish, stain and debris.

First cut is a coarse to medium grit.

Sand two thirds of the floor parallel to the grain.

When the two thirds section is complete, turn sander in the opposite direction and repeat the process on the remaining third. Cuts made in the one-third area must overlap the first cuts by two to three feet to blend the two areas together. To avoid creating a trough be careful not to stop the sander in the exact same spot each pass by staggering the overlap every 2-3 passes.



After the first cut, sand edges and other places, inaccessible to the sanding machine, with an edger using the next sequenced sandpaper that will be used on the sanding machine. Move the edger in an easy semi-circular pattern overlapping into the sanded area, cutting in the direction of the grain whenever possible.

Repeat the sanding procedure with a second cut using a medium or fine grit sandpaper.

Fill the floor prior to the final cut. Spot fill beveled edged products; square edged products should be spot or trowel filled in order to properly fill wide grain patterns.

Repeat edging procedure using the last sequenced grit as on the sanding machine.

Hand scrape corners, around door jambs or other areas where the edger cannot be used. Apply even pressure, scraping in the direction of the grain. After scraping, use a sanding block and paper (same grit as on sanding machine) to blend the flooring. Sanding the groove with the corner of the block may be necessary on bevel-edged products.

Repeat the sanding procedure using the final cut of fine sandpaper. The final sanding should be parallel to the grain.

Use a buffer with a screen over the entire floor. On floors with chatter marks or waves, a hard plate should be used with the appropriate grit of sandpaper before screening.

NOTE: Never operate the sanding machine when the bag is over 1/2 full. Never leave the sanding machine with dust in the bag in your vehicle or on the job sight for lengthy periods of time.

## Chapter 15, Sand & Finish - Strip & Plank Solid Previously Finished

### FINISHING

Inspect the floor carefully for all sanding errors. Repair all sander marks as necessary. After sanding is complete and all sander marks have been repaired, wipe or vacuum up all dust on baseboards, windows, sills, doors, and door frames. Clean from the highest surface to the lowest, in that order. Use a dampened cloth where appropriate on all surfaces except the bare wood floor.

Fill cracks and nail holes with a commercial filler or putty that is compatible with stain and/or finish or make your own filler with dust from the final sanding mixed with a compatible mixing agent to form a thick paste. Apply with a putty knife and scrape off excess.

When dry, hand sand with fine paper.

Sweep or vacuum the floor clean. Repeat vacuuming until floor is clean.

If the floor is to be a natural finish, apply sealer followed by the appropriate finish. If other than a natural color is desired, the floor must be stained or bleached. For bleaching refer to Section IV, Chapter 11.

NOTE: Many manufacturers of stains and finishes recommend using a system, a series of products from the same manufacturer, to insure compatibility and best adhesion. BEFORE USING DIFFERENT MANUFACTURERS FOR THE STAIN AND FINISH PRODUCTS, CHECK WITH THE MANUFACTURER FOR COMPATIBILITY.

Apply the stain according to manufacturer's coverage rate, application method and procedures. The length of time the stain is allowed to remain on the floor, the final sanding procedure and the species of the wood will determine the depth of color. Remove excess stain from within bevels.

Allow the stain to dry thoroughly. Use the manufacturer's recommended drying time. If the environment is excessively humid or cold the stain may take longer to dry. The stain must be completely dry before finishing begins.

Burnish stain if required by manufacturer.

Apply sealer, if necessary, according to manufacturer's recommended coverage rate, application method and procedures. Refer to chart in Section V, Appendix DA.

### OR

For a wax finish apply seal, then wax and buff or burnish into wood.

### OR

For surface finishes, following intercoat abrasion, (see section V, Appendix DD) apply additional coats of finish according to manufacturer's recommendation.

Most surface finished floors can be walked on after 24 hours. Do not slide furniture on the floor, lift it into place after 48 hours or as recommend by the finish manufacturer. Area rugs can be put down after 14 days on water based finishes and 30 days for all other finishes or as recommended by the finish manufacturer.

Furniture or rugs placed too soon may result in finish or surface damage. Some rugs and padding may damage or discolor the finish. This type of damage as well as color change due to aging and intense UV sunlight is not the responsibility of the flooring contractor.



# SECTION IV

## JOBSITE FINISHING & REPAIR

### CHAPTER 16

#### **SAND & FINISH STRIP & PLANK** **ENGINEERED UNFINISHED**

If the floor is installed in an adhesive application, sanding and finishing should occur 24 hours - 3 weeks after the adhesive has cured and the moisture content of the wood has returned to normal.

Remove all furniture, rugs and draperies from room.

Cover light fixtures. Warning, covered lights may be a potential fire hazard, these fixtures should remain off. Tape switch in off position - if necessary.

Redecorating, such as wall-coverings and painting, should be completed and dry before refinishing the floor or wait until sanding is complete.

Remove the base shoe, quarter round or baseboards as needed.

Sweep the floor clean before sanding and after every cut.

Inspect the floor carefully - look for protruding nail heads or staples. Set nails as necessary. Repair and replace all damaged boards.

Seal with plastic or appropriate dust blocker. Cover doorways, heat registers, returns, and windows in work area. Cover windows to keep out direct sunlight. Use the proper tape to hang plastic. NOTE: Some tape will damage paint and wall coverings.

#### Special Considerations Prior to Sanding:

Refer to manufacturer's recommendation for number of times the floor can be sanded and any other recommendations.

The number of sanding depends on the skill of the person sanding the floor, the type of equipment used, the thickness of the remaining wear-layer and the flatness of the floor.

Measure wear layer thickness in several areas and check for flatness to insure whether you should attempt sanding at all. Measurements can often be made at floor registers or by removing transition moldings.

NOTE: Appearance of bevels may not be consistent after sanding.

## Chapter 16, Sand & Finish - Strip & Plank Engineered Unfinished

### SANDING

Load the professional sanding machine and edger with the proper sequence of sandpaper as shown in Section V, Appendix DC.

First cut is a medium to fine grit.

For rotary veneer floors make the first one or two cuts at a 15-degree angle. All other veneer types should be sanded parallel to the grain.

When the two-thirds section is complete turn the sander in the opposite direction and repeat the process on the remaining third. Cuts made in the one-third area must overlap the first cuts by two to three feet to blend the two areas together. To avoid creating a trough be careful not to stop the sander in the exact same spot each pass by staggering the overlap every 2-3 passes. (See Chapter 15, Page 56)

After the first cut, sand edges and other places inaccessible to the sanding machine, with an edger using the next sequenced sand paper that will be used on the sanding machine. Move the edger in an easy semi-circular pattern overlapping into the sanded area cutting in the direction of the grain whenever possible.

Repeat the sanding procedure using the last two sequenced grits as on the sanding machine.

Use the buffer and hard plate disc to make a final cut with the room's longest dimension.

Hand scrape corners, around door jambs or other areas where the edger cannot be used. Apply even pressure, scraping in the direction of the grain. After scraping use a sanding block and paper (same grit as on sanding machine) to blend the flooring. Sanding the groove with the corner of the block may be necessary on bevel-edged products.

Repeat the sanding procedure using the final cut of fine sandpaper. The final sanding should be parallel to the grain.

Use a buffer with a screen over the entire floor. On floors with chatter marks or waves a hard plate should be used with the appropriate grit of sandpaper before screening.

## Chapter 16, Sand & Finish - Strip & Plank Engineered Unfinished

NOTE: Never operate the sanding machine with more than 1/2 full bag. Never leave the sanding machine with dust in the bag in your vehicle or on the job site.

### FINISHING

Inspect the floor carefully for all sanding errors. Repair all sander marks as necessary. After sanding is complete and all sander marks have been repaired, wipe or vacuum up all dust on baseboards, windows, sills, doors and door frames. Clean from the highest surface to the lowest in that order. Use a dampened cloth where appropriate on all surfaces except the bare wood floor.

Fill cracks and nail holes with a commercial filler or putty that is compatible with stain and/or finish or make your own filler with dust from the final sanding mixed with a compatible mixing agent to form a thick paste. Apply with a putty knife and scrape off excess.

When dry, hand sand with fine paper.

Sweep or vacuum the floor clean. Repeat vacuuming until floor is clean.

If the floor is to be a natural finish apply sealer followed by the appropriate finish. If other than a natural color is desired the floor must be stained or bleached. For bleaching refer to Section IV, Chapter 11.

NOTE: Many manufacturers of stains and finishes recommend using a system, a series of products from the same manufacturer, to insure compatibility and best adherence. BEFORE USING DIFFERENT MANUFACTURERS FOR THE STAIN AND FINISH PRODUCTS, CHECK WITH THE MANUFACTURER FOR COMPATIBILITY.

Apply the stain according to manufacturer's coverage rate, application method and procedures. The length of time the stain is allowed to remain on the floor, the final sanding procedure and the species of the wood will determine the depth of color. Remove excess stain from within bevels.

Allow the stain to dry thoroughly. Use manufacturer's recommended drying time. If the environment is excessively humid or cold the stain may take longer to dry. The stain must be completely dry before finishing begins.

Burnish stain if required by manufacturer.

Apply sealer, if necessary, according to manufacturer's recommended coverage rate, application method and procedures. Refer to the chart in Section V, Appendix DA.

## Chapter 16, Sand & Finish - Strip & Plank Engineered Unfinished

### OR

For a wax finish, apply seal, then wax and buff or burnish into wood.

### OR

For surface finishes, following intercoat abrasion, (see section V Appendix DD) apply additional coats of finish according to manufacturer's recommendation.

Most surface finished floors can be walked on after 48 hours. Do not slide furniture on the floor, lift it into place after 48 hours or as recommended by the finish manufacturer. Area rugs can be put down after 14 days on water based finishes and 30 days for all other finishes or as recommended by the finish manufacturer.

Furniture or rugs placed too soon may result in finish or surface damage. Some area rugs and padding may damage or discolor the finish. This type of damage as well as color change due to aging and intense (UV) sunlight is not the responsibility of the flooring contractor.

# SECTION IV

## JOBSITE FINISHING & REPAIR

### CHAPTER 17

#### **SAND & FINISH STRIP & PLANK - ENGINEERED** **PREVIOUSLY FINISHED**

Remove all furniture, rugs and draperies from room.

Cover light fixtures. Warning, covered lights may be a potential fire hazard, these fixtures should remain off. Tape switch in off position if necessary.

Redecorating, such as wall-coverings and painting, should be completed and dry before refinishing the floor or wait until sanding is complete.

Sweep the floor clean before sanding and after every cut.

Inspect the floor carefully - look for protruding nail heads or staples. Set nails as necessary. Repair and replace all damaged boards.

Seal with plastic or appropriate dust blocker. Cover doorways, heat registers, returns, and windows in work area. Cover windows to keep out direct sunlight. Use the proper tape to hang plastic. NOTE: Some tape will damage paint and wall coverings.

#### Special Considerations Prior to Sanding:

Refer to manufacturer's recommendation for number of times the floor can be sanded and any other recommendations.

The number of sandings depends on the skill of the person sanding the floor, the type of equipment used, the thickness of the remaining wear-layer and the flatness of the floor.

Measure wear layer thickness in several areas and check for flatness to insure whether you should attempt sanding at all. Measurements can often be made at floor registers or by removing transition moldings.

NOTE: Appearance of bevels may not be consistent after sanding.

#### SANDING

Load the professional sanding machine and edger with the proper sequence of sandpaper as shown in Section V, Appendix DC.

## Chapter 17, Sand & Finish - Strip & Plank Engineered Previously Finished



First cut is a medium to fine grit.

Replace damaged boards prior to sanding. For badly damaged or cupped floors make the first one or two cuts at a 7 to 15 degree angle to smooth the floor and remove all stain and finish.

The bevels of beveled edge flooring should be scraped and cleaned to remove finish, stain and debris.

For rotary veneer make the first one or two cuts at a 7 to 15 degree angle to smooth the floor and remove all finish and stain. All other veneer types should be sanded parallel to the grain.

Sand two thirds of the floor lengthwise at the angle recommended above.

When the two thirds section is complete turn sander in the opposite direction and repeat the process on the remaining third. Cuts made in the one-third area must overlap the first cuts by two to three feet to blend the two areas together. To avoid creating a trough, be careful not to stop the sander in the exact same spot each pass by staggering the overlap every 2-3 passes.

After the first cut, sand edges and other places, inaccessible to the sanding machine, with an edger using the next sequenced sandpaper that will be used on the sanding machine. Move the edger in an easy semicircular pattern overlapping into the sanded area, cutting in the direction of the grain to whenever possible.

## Chapter 17, Sand & Finish - Strip & Plank Engineered Previously Finished

Repeat the sanding procedure with a second cut using medium or fine grit sandpaper.

Fill the floor prior to the final cut. Spot fill beveled edged products; square edged products should be spot or trowel filled in order to properly fill wide grain patterns.

Repeat edging procedure using the last sequenced grit as on the sanding machine.

Hand scrape corners, around door jambs or other areas where the edger cannot be used. Apply even pressure, scraping in the direction of the grain. After scraping use a sanding block and paper (same grit as on sanding machine) to blend the flooring. Sanding the groove with the corner of the block may be necessary on bevel-edged products.

Repeat the sanding procedure using the final cut of fine sandpaper. The final sanding should be parallel to the grain.

Use a buffer with a screen over the entire floor. On floors with chatter marks or waves, a hard plate should be used with the appropriate grit of sandpaper before screening.

NOTE: Never operate the sanding machine when the bag is over 1/2 full. Never leave the sanding machine with dust in the bag in your vehicle or on the job site.

### FINISHING

Inspect the floor carefully for all sanding errors. Repair all sander marks as necessary. After sanding is complete and all sander marks have been repaired, wipe or vacuum up all dust on baseboards, windows, sills, doors, and door frames. Clean from the highest surface to the lowest, in that order. Use a dampened cloth where appropriate on all surfaces except the bare wood floor.

Fill cracks and nail holes with a commercial filler or putty that is compatible with stain and/or finish or make your own filler with dust from the final sanding mixed with a compatible mixing agent to form a thick paste. Apply with a putty knife and scrape off excess.

When dry, hand sand with fine paper.

Sweep or vacuum the floor clean. Repeat vacuuming until floor is clean.

If the floor is to be a natural finish apply sealer followed by the appropriate finish. If other than a natural color is desired the floor must be stained. For bleaching refer to Section IV, Chapter 11.

## Chapter 17, Sand & Finish - Strip & Plank Engineered Previously Finished

NOTE: Many manufacturers of stains and finishes recommend using a system, a series of products from the same manufacturer, to insure compatibility and best adhesion. Before using different manufacturers for the stain and finish products, check with the manufacturer for compatibility.

Apply the stain according to manufacturer's coverage rate, application method and procedures. The length of time the stain is allowed to remain on the floor, the final sanding procedure and the species of the wood will determine the depth of color. Remove excess stain from within bevels.

Allow the stain to dry thoroughly. Use manufacturer's recommended drying time. If the environment is excessively humid or cold the stain may take longer to dry. **The stain must be completely dry before finishing begins.**

Burnish stain if required by manufacturer.

Apply sealer, if necessary, according to manufacturer's recommended coverage rate, application method and procedures. Refer to the chart in Section V, Appendix DA.

### OR

For a wax finish apply seal, then wax and buff or burnish into wood.

### OR

For surface finishes, following intercoat abrasion, (see section V, Appendix DD) apply additional coats of finish according to manufacturer's recommendation.

Most surface finished floors can be walked on after 48 hours. Do not slide furniture on the floor, lift it into place after 48 hours or as recommended by the finish manufacturer. Area rugs can be put down after 14 days on water based finishes and 30 days for all other finishes or as recommended by the finish manufacturer.

Furniture or rugs placed too soon may result in finish or surface damage. Some area rugs and padding may damage or discolor the finish. This type of damage as well as color change due to aging and intense (UV) sunlight is not the responsibility of the flooring contractor.



# SECTION IV

## JOBSITE FINISHING & REPAIR

### CHAPTER 18

#### SAND & FINISH - PARQUET - SOLID OR ENGINEERED - UNFINISHED

Sanding and finishing should occur 24 hours - 3 weeks after the adhesive has cured and the moisture content of the wood has returned to normal.

Remove all furniture, rugs, and draperies from room.

Cover light fixtures. Warning, covered lights may be a potential fire hazard, these fixtures should remain off. Tape switch in off position if necessary.

Redecorating, such as wall-coverings and painting, should be completed and dry before refinishing the floor or wait until sanding is complete.

Sweep the floor clean before sanding and after every cut.

Inspect the floor carefully - look for protruding nail heads or staples. Set nails as necessary. Repair and replace all damaged boards.

Seal with plastic or appropriate dust blocker. Cover doorways, heat registers, returns, and windows in work area. Cover windows to keep out direct sunlight. Use the proper tape to hang plastic. NOTE: Some tape will damage paint and wall coverings.

#### Special Considerations Prior to Sanding:

Refer to manufacturer's recommendation for number of times the floor can be sanded and any other recommendations.

The number of sandings depends on the skill of the person sanding the floor, the type of equipment used, the thickness of the remaining wear-layer and the flatness of the floor.

Measure wear layer thickness in several areas and check for flatness to insure whether you should attempt sanding at all. Measurements can often be made at floor registers or by removing transition moldings.

NOTE: Appearance of bevels may not be consistent after sanding.

## Chapter 18, Sand & Finish - Parquet - Solid or Engineered - Unfinished

### SANDING

Load the professional sanding machine and edger with the proper sequence of sandpaper as shown in Section V, Appendix DC.

For the first cut use the minimum grit required to flatten the floor (species dependent). Make the first sanding cut diagonal to the grain.

After the first cut, sand edges and other places inaccessible by the sanding machine with an edger using the last sequenced sandpaper as on the sanding machine. Move the edger in an easy semi-circular pattern overlapping into the sanded area and cutting in the direction of the grain whenever possible.

Fill floor between sanding as necessary.

Make the second cut on the opposite diagonal with the next sequenced sandpaper.

Fill floor between sanding as necessary.

Repeat edging procedure using the last sequenced grit as on sanding machine.

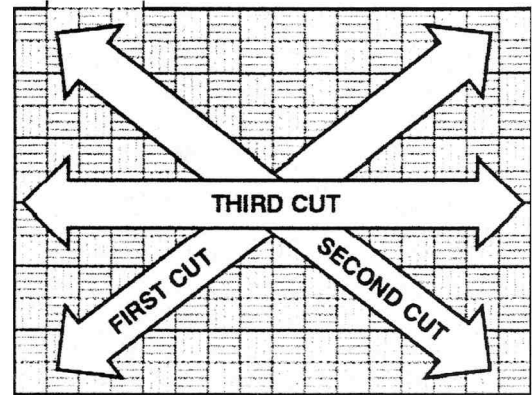

Hand scrape corners, around door jambs or other areas where the edger cannot be used. Apply even pressure, scraping in the direction of the grain. After scraping use a sanding block and paper (same grit as on sanding machine) to blend the flooring. Sanding the groove with the corner of the block may be necessary on bevel-edged products.

Repeat sanding procedure using final sequenced grit of sandpaper.

Use the buffer and hard plate disc to make a final cut with the room's longest dimension.

Use a screen over the entire floor, and hand sand edged areas with the last grit paper used on sanding machine. On floors with chatter marks or waves a hard plate should be used before hand sanding.

NOTE: Never operate the sanding machine with more than 1/2 full bag. Never leave the sanding machine with residue in the bag on the job site overnight. Never leave the sanding machine with residue in the bag in your truck overnight.

## Chapter 18, Sand & Finish - Parquet - Solid or Engineered - Unfinished

### FINISHING

Inspect the floor carefully for all sanding errors. Repair all sander marks as necessary. After sanding is complete and all sander marks have been repaired, wipe or vacuum up all dust on baseboards, windows, sills, doors, and door frames. Clean from the highest surface to the lowest, in that order. Use a dampened cloth where appropriate on all surfaces except the bare wood floor.

Fill cracks and nail holes with a commercial filler or putty that is compatible with stain and/or finish or make your own filler with dust from the final sanding mixed with a compatible mixing agent to form a thick paste. Apply with a putty knife and scrape off excess.

When dry, hand sand with fine paper.

Sweep or vacuum the floor clean. Repeat vacuuming until floor is clean.

If the floor is to be a natural finish apply sealer followed by the appropriate finish. If other than a natural color is desired the floor must be stained or bleached. For bleaching refer to Section IV, Chapter 11.

NOTE: Many manufacturers of stains and finishes recommend using a system, a series of products from the same manufacturer, to insure compatibility and best adhesion. Before using different manufacturers for the stain and finish products, check with the manufacturer for compatibility.

Apply the stain according to manufacturer's coverage rate, application method and procedures. The length of time the stain is allowed to remain on the floor, the final sanding procedure and the species of the wood will determine the depth of color. Remove excess stain from within bevels.

Allow the stain to dry thoroughly. Use the manufacturer's recommended drying time. If the environment is excessively humid or cold the stain may take longer to dry. The stain must be completely dry before finishing begins.

Burnish stain if required by manufacturer.

Apply sealer, if necessary, according to manufacturer's recommended coverage rate, application method and procedures. Refer to the chart in Section V, Appendix DA.

**OR**

For a wax finish apply seal, then wax and buff or burnish into wood.

## Chapter 18, Sand & Finish - Parquet - Solid or Engineered - Unfinished

### OR

For surface finished, following intercoat abrasion, (see section V Appendix DD) apply additional coats of finish according to manufacturer's recommendation.

Most surface finished floors can be walked on after 48 hours. Do not slide furniture on the floor, lift it into place after 48 hours or as recommended by the finish manufacturer. Area rugs can be put down after 14 days on water based finishes and 30 days for all other finishes or as recommended by the finish manufacturer.

Furniture or rugs placed too soon may result in finish or surface damage. Some area rugs and padding may damage or discolor the finish. This type of damage as well as color change due to aging and intense UV sunlight is not the responsibility of the flooring contractor.

# SECTION IV

## JOBSITE FINISHING & REPAIR

### CHAPTER 19

#### **SAND & FINISH - PARQUET - SOLID OR ENGINEERED PREVIOUSLY FINISHED**

Sanding and finishing should occur 24 hours - 3 weeks after the adhesive has cured and the moisture content of the wood has returned to normal.

Remove all furniture, rugs and draperies from room.

Cover light fixtures. Warning, covered lights may be a potential fire hazard, these fixtures should remain off. Tape switch in off position if necessary.

Redecorating, such as wall-coverings and painting, should be completed and dry before refinishing the floor or wait until sanding is complete.

Sweep the floor clean before sanding and after every cut.

Inspect the floor carefully - look for protruding nail heads or staples. Set nails as necessary. Repair and replace all damaged boards.

Seal with plastic or appropriate dust blocker. Cover doorways, heat registers, returns, and windows in work area. Cover windows to keep out direct sunlight. Use the proper tape to hang plastic. NOTE: Some tape will damage paint and wall coverings.

#### Special Considerations Prior to Sanding:

Refer to manufacturer's recommendation for number of times the floor can be sanded and any other recommendations.

The number of sandings depends on the skill of the person sanding the floor, the type of equipment used, the thickness of the remaining wear-layer and the flatness of the floor.

Measure wear layer thickness in several areas and check for flatness to insure whether you should attempt sanding at all. Measurements can often be made at floor registers or by removing transition moldings.

NOTE: Appearance of bevels may not be consistent after sanding.

#### SANDING

Load the professional sanding machine and edger with the proper sequence of sandpaper as shown in Section V, Appendix DC.

Replace damaged pieces.

## Chapter 19, Sand & Finish - Parquet - Solid or Engineered Previously Finished

The bevels of beveled edge flooring should be scraped and cleaned to remove finish, stain and debris.

For first cut use minimum grit required to flatten the floor and remove all stain and finish. Make the first sanding cut diagonal to the grain.

After the first cut, sand edges and other places inaccessible to the sanding machine with an edger using the last sequenced sandpaper as on the sanding machine. Move the edger in an easy semi-circular pattern overlapping into the sanded area and cutting in the direction of the grain whenever possible.

Fill floor between sanding as necessary.

Make the second cut on the opposite diagonal with the next sequenced sandpaper.

Fill floor between sanding as necessary.

Repeat edging procedure using the last sequenced grit as on the sanding machine.

Hand scrape corners, around door jambs or other areas where the edger cannot be used. Apply even pressure, scraping in the direction of the grain. After scraping use a sanding block and paper (same grit as on sanding machine) to blend the flooring. Sanding the groove with the corner of the block may be necessary on bevel-edged products.

Repeat sanding procedure using final sequenced grit of sandpaper.

Use a buffer and hard plate disc to make a final cut with the room's longest dimension.

Use a screen over the entire floor, and hand sand edged areas with the last grit paper used on sanding machine. On floors with chatter marks or waves a hard plate should be used before hand sanding.

**NOTE:** Never operate the sanding machine with more than 1/2 full bag. Never leave the sanding machine with residue in the bag on the job site overnight. Never leave the sanding machine with residue in the bag in your truck overnight.

### FINISHING

Inspect the floor carefully for all sanding errors. Repair all sander marks as necessary. After sanding is complete and all sander marks have been repaired, wipe or vacuum up all dust on baseboards, windows, sills, doors, and door frames. Clean from the highest surface to the lowest, in that order. Use a dampened cloth where appropriate on all surfaces except the bare wood floor.

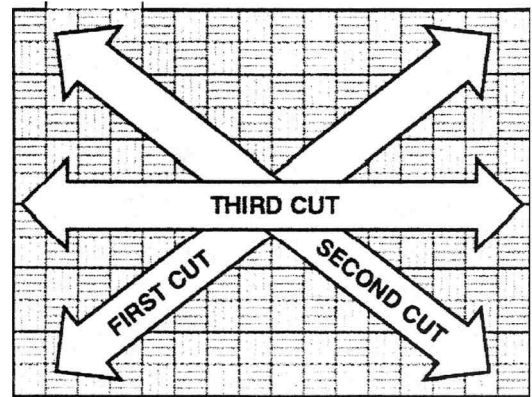

## Chapter 19, Sand & Finish - Parquet - Solid or Engineered Previously Finished

Fill cracks and nail holes with a commercial filler or putty that is compatible with stain and/or finish or make your own filler with dust from the final sanding mixed with a compatible mixing agent to form a thick paste. Apply with a putty knife and scrape off excess.

When dry, hand sand with fine paper.

Sweep or vacuum the floor clean. Repeat vacuuming until floor is clean.

If the floor is to be a natural finish apply sealer followed by the appropriate finish. If other than a natural color is desired the floor must be stained or bleached. For bleaching refer to Section IV, Chapter 11.

NOTE: Many manufacturers of stains and finishes recommend using a system, a series of products from the same manufacturer, to insure compatibility and best adhesion. BEFORE USING DIFFERENT MANUFACTURERS FOR THE STAIN AND FINISH PRODUCTS, CHECK WITH THE MANUFACTURER FOR COMPATIBILITY.

Apply the stain according to manufacturer's coverage rate, application method and procedures. The length of time the stain is allowed to remain on the floor, the final sanding procedure and the species of the wood will determine the depth of color. Remove excess stain from within bevels.

Allow the stain to dry thoroughly. Use the manufacturer's recommended drying time. If the environment is excessively humid or cold the stain may take longer to dry. The stain must be completely dry before finishing begins.

Burnish stain if required by manufacturer.

Apply sealer, if necessary, according to manufacturer's recommended coverage rate, application method and procedures. Refer to the chart in Section V, Appendix DA.

### **OR**

For a wax finish apply seal, then wax and buff or burnish into wood.

### **OR**

For surface finished, following intercoat abrasion, (see section V, Appendix DD) apply additional coats of finish according to manufacturer's recommendation.

Most surface finished floors can be walked on after 48 hours. Do not slide furniture on the floor, lift it into place after 48 hours or as recommended by the finish manufacturer. Area rugs can be put down after 14 days on water based finishes and 30 days for all other finishes or as recommended by the finish manufacturer.

Furniture or rugs placed too soon may result in finish or surface damage. Some area rugs and padding may damage or discolor the finish. This type of damage as well as color change due to aging and intense (UV) sunlight is not the responsibility of the flooring contractor.

# SECTION IV

## JOBSITE FINISHING & REPAIR

### CHAPTER 20

#### **RECOATING EXISTING SURFACE FINISHED FLOOR**

Finish adhesion is affected by surface contaminants, i.e. wax, grease and many other maintenance products. One brand or type of finish may not be compatible with another. Always test in several areas in accordance with finish manufacturer's recommendations to be sure the finish will adhere and dry properly.

NOTE: Closets may not be the best test area because wax, maintenance and other finishes are used on the main body of the floor, but usually not in closets.

TESTING IN ONE AREA DOES NOT GUARANTEE ACCEPTABLE PERFORMANCE

Clean the floor in accordance with the finish manufacturer's recommendations.

Lightly abrade the old finish according to finish manufacturer recommendation. (See Section V, Appendix DD)

Vacuum and tack floor with proper solvent dependent on finish and allow to dry thoroughly. (See Section V, Appendix DD)

Apply surface finish according to manufacturer's recommended cover rate using manufacturer's recommended applicator and procedure.

Most surface finished floors can be walked on after 48 hours. Do not slide furniture on the floor, lift it into place after 48 hours or as recommended by the finish manufacturer. Area rugs can be put down after 14 days on water based finishes and 30 days for all other finishes or as recommended by the finish manufacturer.

Furniture or rugs placed too soon may result in finish or surface damage. Some area rugs and padding may damage or discolor the finish. This type of damage as well as color change due to aging and intense UV sunlight is not the responsibility of the flooring contractor.



# SECTION V

## APPENDIX

### Appendix A

Moisture Testing Procedures for Concrete Slabs	Page AA
Moisture Testing for Wood	Page AB
Crawl Space Moisture Barrier Diagram	Page AC
Moisture by Area - United States	Page AD
Moisture by Area - Canada	Page AE
Subfloor Grade Levels	Page AF

### Appendix B

Guide to Hardwood Flooring Grades	Page BA
-----------------------------------	---------

### Appendix C

Fastener Schedule	Page CA
-------------------	---------

### Appendix D

Applicator Recommendations	Page DA
Finish Chart	Page DB
Abrasive Guide	Page DC
Intercoat Abrasion	Page DD

### Appendix E

Jobsite Checklist	Page EA
Tools Checklist	Page EB

# SECTION V

## APPENDIX AA

### MOISTURE TESTING PROCEDURES FOR CONCRETE SLABS

Before moisture testing begins, the concrete slab must be a MINIMUM of 30 days old. Testing of slabs less than 30 days old can produce inaccurate,unreliable results. PH testing should be done on all slabs regardless of age.

#### Testing with Moisture Meter

NOTE: If the moisture meter used does not give a quantified number for moisture in the concrete slab, but indicates the presence of moisture, then the Calcium Chloride test needs to be run.

Test with an accepted moisture meter at each outside wall and 1-5 times in center area depending on size of room - residential.

Test with an accepted moisture meter at each outside wall and every 6' (1800mm) in center area - commercial

#### Testing Methods without Moisture Meter

Polyfilm:

One test per 200 s/f (minimum 2 tests per jobsite)

Completely tape down 2' X 2' (600mm X 600mm) polyfilm squares and leave them for 48 hours. Check for condensation under the plastic. Condensation indicates slab has moisture. Noticeable color changes indicates moisture.

Phenolphthalein

One test per 200 s/f (minimum 2 tests per jobsite)

Chip small section of concrete off floor and apply 3% Phenolphthalein in alcohol solution (available at most druggists) in the area. Red color indicates moisture. ALWAYS chip concrete as this protects against the possibility that a concrete sealer was applied.

IMPORTANT: Keep Phenolphthalein out of direct sunlight. Average shelf life of Phenolphthalein is six (6) months.

NOTE: IF ANY OF THESE TESTS INDICATE MOISTURE IS PRESENT IN THE SLAB, THE CALCIUM CHLORIDE TEST SHOULD BE RUN.

## Appendix AA, Moisture Testing Procedure for Concrete Slab

### CALCIUM CHLORIDE TEST \*

One test per 1,000 s/f for 24 hours.

Instructions per Test Kit:

The surface where the test patch is to be placed must be brushed clean to remove any waxes, surface sealers, dust, dirt, oils or other surface contaminant's. At the time the test is conducted, the temperature of the floor and the surrounding area should be at least 65 degrees Fahrenheit.

Leaving no gaps, apply the sealant tape completely around the perimeter of the plastic cover.

Remove the lid from the plastic dish containing the calcium chloride and, being careful not to spill any of the calcium chloride, place the dish on the floor (remember to save the tape to reseal the lid to the cylindrical dish after the test is concluded).

Immediately place the plastic cover over the calcium chloride dish and press the cover firmly to the floor making certain that the sealant gives an airtight seal around the plastic cover.

Leave the test undisturbed for the time prescribed in the test kit instructions. Note the date and exact time the test was started on the dish label.

At the end of the prescribed time, remove the cover and reseal the lid to the dish again being sure that none of the calcium chloride is spilled. Note the date and exact time the test was concluded on the label.

The test is then sent to a laboratory and documentation will be returned, (See manufacturers instructions on Calcium Chloride kits). Or you can purchase a scale and do the measurements in house.

<u>RESULTS</u>	<u>INDICATES</u>
0-3 lbs	dry*
over 3 lbs	moisture barrier required
over 7 lbs	too wet

\*Calcium Chloride kits are generally available through your distributor or call NWFA at 800-422-4556 U.S. or 800-848-8824 Canada for the source nearest you.

ALWAYS FOLLOW MANUFACTURERS INSTRUCTIONS FOR ACCEPTABLE MOISTURE BARRIERS.

## Appendix AA, Moisture Testing Procedure for Concrete Slab

A MOISTURE BARRIER IS ALWAYS RECOMMENDED OVER CONCRETE WHEN INSTALLING SOLID WOOD FLOORING.

### Acceptable Moisture Barriers

- Low end PVC vinyl applied over the slab following manufacturers recommended procedures.
- Polyfilm, 6 mil polyethylene film if glued, 8 mil polyethylene if loose lay, applied in accordance with manufacturers accepted recommendations.
- Double felt, two layers of 15# asphalt saturated felt paper that meets ASTM Standard D4869 with first layer adhered to the slab in a "skim" coat of appropriate adhesive, and second layer adhered to the first layer with appropriate adhesive.
- Epoxy sealer.
- Adhesive system recommended by the manufacturer.

NOTE: Test for curing sealers on concrete. If present, sand with (20 grit) #3 1/2 paper.

WHETHER YOU FIND THERE IS MOISTURE PRESENT OR NOT, AND ESPECIALLY ON COMMERCIAL JOBS, IT IS SUGGESTED THAT YOU DO AN ALKALINITY TEST ON THE CONCRETE SLAB.

A PH range of 5-9 is satisfactory. A reading above 9 requires corrective measures.

### TESTING FOR PH

There are several testing methods, but the most practical is with ph test papers.

Sweep the test area clean and apply a few drops of distilled water to the surface. Slightly scrape the wet area with a screwdriver or similar tool to break up any matrix that might have formed on the surface. Once the wet area is scraped, a strip of ph paper can be placed directly into the test area. Within five minutes, it will have turned to a color that can be compared to the color chart on the side of the box containing the ph test papers.

Orange ranges indicate neutral.

Light greens indicate acceptable but reaching borderline.

Dark green, blue or purple are danger signs.

## Appendix AA, Moisture Testing Procedure for Concrete Slab

In the danger range the slab can be neutralized by washing the floor with a recommended acid solution.

**NOTE:** Check with Portland Cement Association for appropriate solution.

In less than severe situations, a slab can be neutralized with a 30 percent solution of vinegar and water. The washing and rinsing process are the same.

The slab should be checked again with a ph paper for the correct range and moisture content.

# SECTION V

## APPENDIX AB

### MOISTURE TESTING FOR WOOD

The determination of moisture content is an essential part of quality control within the flooring installation process. Flooring installers must know the dryness of not only the wood flooring but also its subfloor. Hand-held electrical tools, called moisture meters, should be part of the toolbox of every flooring contractor, for measuring moisture in sub-floors and floors.

Moisture meters have many purposes. They can determine if floorboards are dry enough for an installation to proceed. They can check subfloors and concrete for high moisture levels; they can decide when a second coat of finish can be applied; they can assess water damage.

There are two main types of meters - probe and pinless.

The probe type, measures electrical resistance across opposed sets of pins, which are pushed into the wood. The probe must be inserted parallel with the grain, along the face of the board at least 2" from the ends.

One advantage of probe type meters is that those with insulated pins can measure moisture content at varying depths - you can tell whether the moisture content near the bottom of a board is higher than near the top, for example.

The pinless, dielectric types are quite different.

Signal penetration for pinless meters is up to 1 inch for both hardwood and softwood. The meter can be moved across the surface to identify pockets of moisture in a wood block or plank. It is relatively unaffected by temperature. Rough surfaces have very little effect on the reading. Measurements can also be taken through coating; varnish or paint without damage to the surface.

It is important that the meter you choose offers the following:

- \*A wide moisture content range from at least 6 percent to 30 percent. (The accuracy of readings outside of these limits is generally considered questionable.)
- \*A clear analog or digital dial.
- \*The necessary adjustment tables for various species.

## Appendix AB, Moisture Testing for Wood

Wood subfloors are actually easy to check for moisture content. Just test for moisture at several locations in the room and average the results. In most regions, a “dry” subfloor that is ready to work on has a moisture content of 12 percent or less. If excessively high readings are obtained, installation should not proceed until the origin of the moisture is identified and moisture problems are remedied. During the winter, an overly moist subfloor can be dried out by running the heat for a few weeks. Air conditioning during the summer will do the same thing.

Before flooring can be installed, the moisture content of the subfloor should be within 4 percentage points of the flooring that will be laid on it.

If the moisture content between the flooring and subflooring varies more than 4 percentage points, then the flooring should not be installed.

### Equilibrium Moisture Content

The moisture content of wood below the fiber saturation point is a function of both relative humidity and temperature in the surrounding air. When wood is neither gaining nor losing moisture, an equilibrium moisture content (EMC) has been reached.

Wood technologists have graphs that precisely tie EMC and relative humidity together, but as a rule of thumb at 70° Fahrenheit, a relative humidity of 25 percent gives an EMC of 5 percent, and a relative humidity of 75 percent gives an EMC of 14 percent. (See Section V, Appendix AB-3)

A 50 percent variance in relative humidity produces an EMC change of 10 percent. How that affects wood flooring depends on which species is being used. However, let’s say the width variation is just 1/16 inch for a 2 1/4 inch board. That’s a full inch over 16 boards in a floor. Over the width of a 10-foot wide floor, that amounts to more than three inches of total expansion or contraction.

Protective coatings cannot prevent wood from gaining or losing moisture; they merely slow the process.

## WOOD FLOORING HAS A COMFORT LEVEL, TOO

Wood flooring will perform best when the fluctuation in the environment is controlled to stay within a relative humidity range of 20 percent (ie 20-40 percent) and a temperature range of 20 degrees Fahrenheit. Fortunately, that’s about the same comfort range most humans enjoy. The chart below indicates the moisture content wood will likely have at any given combination of temperature and humidity. Note that equilibrium moisture contents in the temperature/humidity range (shaded area) coincide with the 6-9 percent range within which most hardwood flooring is manufactured. Although some movement can be expected even between 6 and 9 percent, wood can expand and shrink dramatically when the relative humidity changes are greater than 20 percent. (See Section V, Appendix AB-3)

**Appendix AB, Moisture Testing for Wood**

**MOISTURE CONTENT OF WOOD  
AT VARIOUS TEMPERATURES AND RELATIVE HUMIDITY READINGS**

**Temperature (°Fahrenheit)**

<b>30</b>	1.4	2.6	3.7	4.6	5.5	6.3	7.1	7.9	8.7	9.5	10.4	11.3	12.4	13.5	14.9	16.5	18.5	21.0	24.3	26.9
<b>40</b>	1.4	2.6	3.7	4.6	5.5	6.3	7.1	7.9	8.7	9.5	10.4	11.3	12.4	13.5	14.9	16.5	18.5	21.0	24.3	26.9
<b>50</b>	1.4	2.6	3.7	4.6	5.5	6.3	7.1	7.9	8.7	9.5	10.4	11.3	12.4	13.5	14.9	16.5	18.5	21.0	24.3	26.9
<b>60</b>	1.3	2.5	3.6	4.6	5.4	6.2	7.0	7.8	8.6	9.4	10.2	11.1	12.1	13.3	14.6	16.2	18.2	20.7	24.1	26.8
<b>70</b>	1.3	2.5	3.5	4.5	5.4	6.2	6.9	7.7	8.5	9.2	10.1	11.0	12.0	13.1	14.4	16.0	17.9	20.5	23.9	26.6
<b>80</b>	1.3	2.4	3.5	4.4	5.3	6.1	6.8	7.6	8.3	9.1	9.9	10.8	11.7	12.9	14.2	15.7	17.7	20.2	23.6	26.3
<b>90</b>	1.2	2.3	3.4	4.3	5.1	5.9	6.7	7.4	8.1	8.9	9.7	10.5	11.5	12.6	13.9	15.4	17.3	19.8	23.3	26.0
<b>100</b>	1.2	2.3	3.3	4.2	5.0	5.8	6.5	7.2	7.9	8.7	9.5	10.3	11.2	12.3	13.6	15.1	17.0	19.5	22.9	25.6
	<b>5</b>	<b>10</b>	<b>15</b>	<b>20</b>	<b>25</b>	<b>30</b>	<b>35</b>	<b>40</b>	<b>45</b>	<b>50</b>	<b>55</b>	<b>60</b>	<b>65</b>	<b>70</b>	<b>75</b>	<b>80</b>	<b>85</b>	<b>90</b>	<b>95</b>	<b>98</b>

**Relative Humidity (percent)**

Chart taken from Wood Handbook; Wood as an Engineering Material,(Agriculture Handbook 72),  
Forest Products Laboratory, U.S. Department of Agriculture.



**SECTION V**  
**APPENDIX AC**  
**CRAWL SPACE MOISTURE BARRIER DIAGRAM**

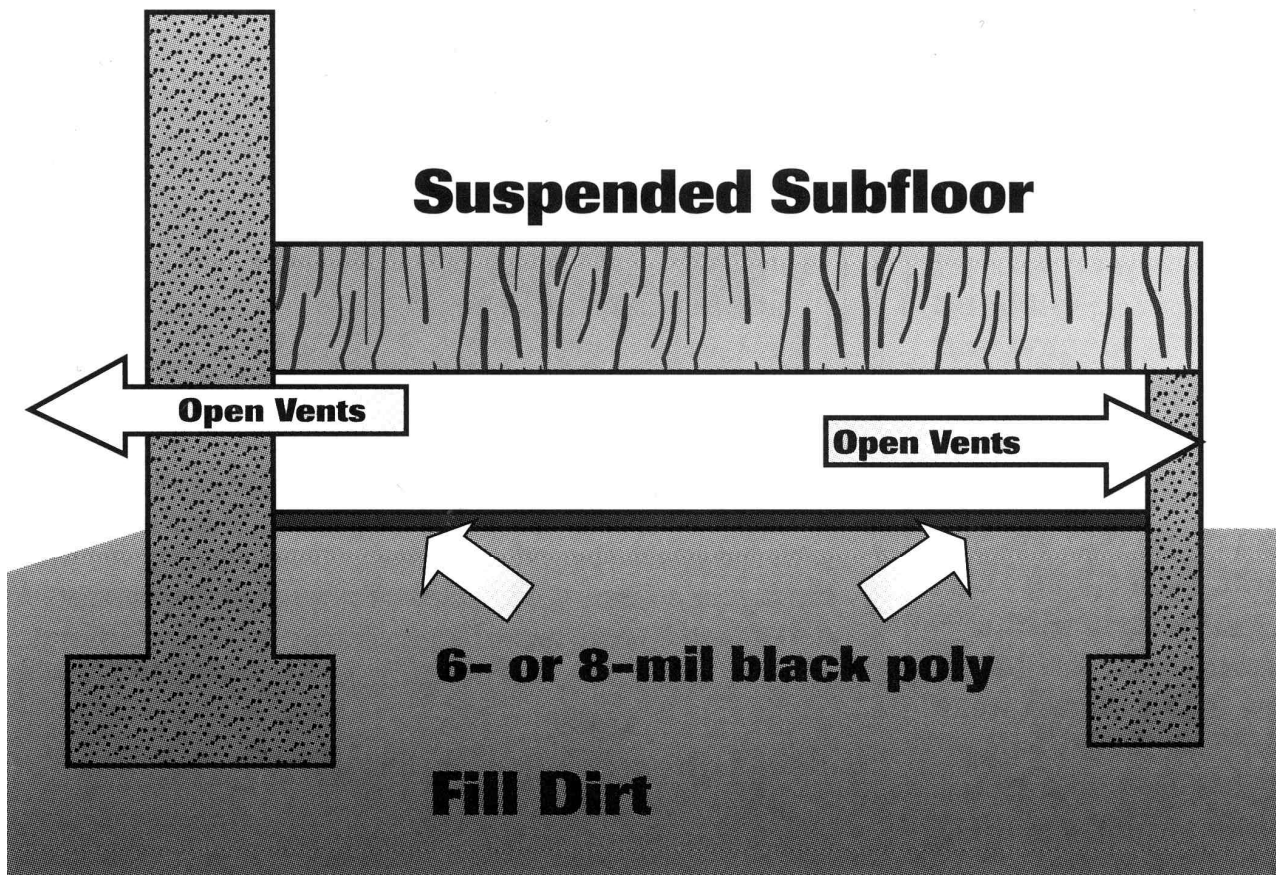

*In crawl space construction, 6- or 8-mil plastic, (preferably black) should cover the entire ground area.*

Crawl space should have 1.5% of open venting per 1,000 s/f (92.90 sq. meters) of floor area properly located to foster cross ventilation.

# SECTION V

## APPENDIX AD

### MOISTURE BY AREA - U.S.

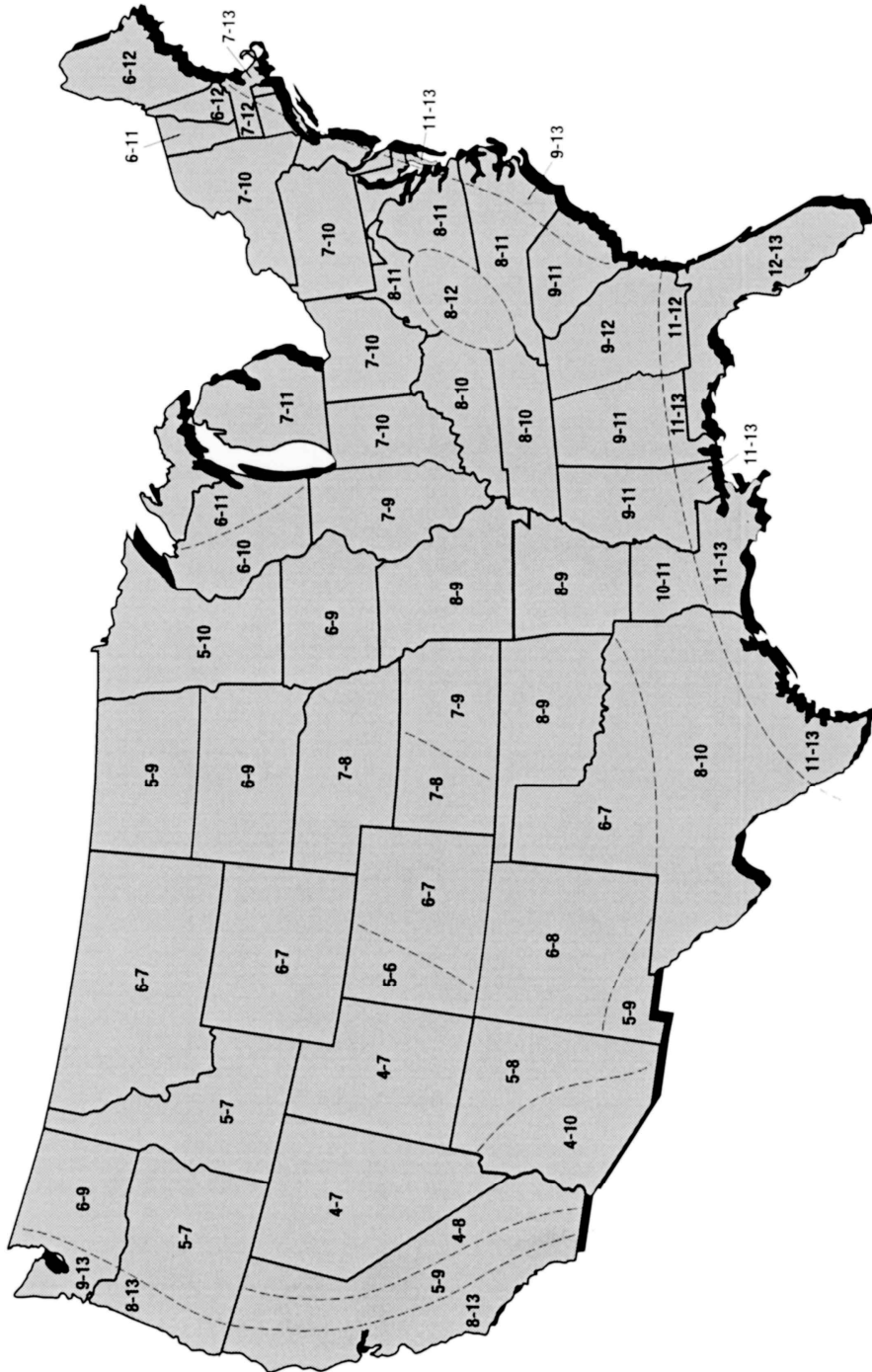

NOTE: Relative humidity in the building should be maintained between 30-50% year round. The key to wood floor performance is consistent environment.

# SECTION V

## APPENDIX BA

### GUIDE TO HARDWOOD FLOORING GRADES

#### OAK FLOORING GRADING RULES

##### **NOFMA Clear Oak**

A flooring product of mostly heartwood with a minimum number of character marks and discoloration, providing a uniform appearance while allowing for all heartwood natural color variations.

Will admit the following:

3/8" bright sapwood entire length of strip or equivalent if not extending further than 1" for 1/3 length of piece; small burls and fine pin worm holes; and equivalent characters such as small tight checks; in the absence of these, one thin brown streak 3" long to be allowed every 6".

Standard Packaging - Bundles to be 1-1/4' and longer; Average length, bundled or nested, 3-3/4'.

Shorter Packaging - Average length for 7' and shorter packages, nested or otherwise, 3-1/2'.

##### **NOFMA Select Oak**

A flooring product with coloration variations produced by differences of natural heartwood and sapwood, along with characters described.

The face may contain:

unlimited sound sapwood; slight imperfections in milling; a small tight knot every 3'; pin worm holes; burls and a reasonable amount of slightly open checks. Brown streaks should not extend the entire length of a piece. Two flag worm holes to every 8' are permitted. Slight imperfections in face work (torn grain) admitted. An intermittent, brown machine burn across the face not exceeding 1/4" width admitted. Also, a slight quantity of bark on the back or sides admitted. Will admit pieces with 1/2 tongue. Spot filling is generally required for open characters.

Standard Packaging - Bundles to be 1-1/4' and longer; Average length, bundled or nested, 3-1/4'.

Shorter Packaging - Average length for 7" and shorter packages, nested or otherwise, 3'.

##### **NOFMA No. 1 Common Oak**

A flooring product which contains prominent variations in coloration and varying characters.

## Appendix BA, Guide to Hardwood Flooring Grades

The following are not admitted:

broken knots over 1/2" in diameter, large grub worm holes, and splits extending through the piece. Open characters such as checks and knot holes are admitted, but must be sound and readily fill. Not more than 20" scant stock in thickness allowed to every 5'. Minor imperfections in machining permitted. Shall admit sticker stain; varying wood characteristics, such as flag worm holes, heavy streaks, checks, and worm holes; and as occasional dark machine burn across the face not exceeding 1/2" wide, 1/64" deep and not more than two each 3' 1/4 tongue allowed. Extremely dark pieces are not to be included.

Standard Packaging - Bundles to be 1-1/4' and longer; Average length, bundled or nested, 2-3/4'.

Shorter Packaging - Average length for 7' and shorter packages, nested or otherwise, 2-1/2'.

### **NOFMA No. 2 Common Oak**

May contain sound natural variations of the forest product and manufacturing imperfections. The purpose of this grade is to furnish a floor suitable for homes, general utility use, or where character marks and contrasting appearance is desired.

The following are not admitted:

shattered or rotten ends, large broken knots, excessive bad millwork, shake, advanced rot, and similar unsound defects. Dark machine burns exceeding 3/64" deep not admitted. Knot holes and open characters which will readily fill are admitted. A limited number of pieces with no tongue which may be face nailed are admitted.

Standard Packaging - Bundles to be 1-1/4' and longer; Average length, bundled or nested, 2-1/4'.

Shorter Packaging - Average length for 7' and shorter packages, nested or otherwise, 2'.

### **NOFMA 1-1/4' ft. SHORTS OAK**

Pieces 9" to 18" long are to be bundled together and designated as 1-1/4' Shorts. Pieces graded NO. 1 COMMON, SELECT and CLEAR to be bundled together and designated NO. 1 COMMON & BETTER with pieces grading NO. 2 COMMON bundled separately and designated as such. Although pieces 6" under and only 3" over the nominal length of the bundle may be included, the pieces must average 1-1/4' which is achieved through the natural preponderance of longer lengths.

BEECH (*Fagus grandifolia*)

BIRCH (*Betula alleghaniensis* B. *lenta*)

& HARD MAPLE (*Acer saccharum*)

GRADING RULES

## **Appendix BA, Guide to Hardwood Flooring Grades**

NOFMA recognizes 3/4", 25/32" and 33/32" as standard thickness for the manufacturer of Hard Maple, Beech, and Birch flooring. NOFMA members may, at their option, produce either 25/32" or 3/4" thick Hard Maple, Beech and Birch flooring.

### **NOFMA Select and better Beech, Birch & Hard Maple**

Shall have the face practically free of all defects, but the natural color of the wood shall not be considered a defect. The highest standard grade, combines appearance and durability.

Will admit the following:

variations in the Natural Color of the wood (with use of some finishes, slight shadows and color variation may appear); an occasional small, firm Pin Knot, not over 1/8" in diameter, provided it does not occur on edges or ends of strips; occasional dark Green or Black Spots or Streaks not over 1/4" wide and 3" long (or its equivalent) which may contain a tight check not over 1/2" long, provided it is boxed within the piece; Bird's Eyes and small Burls; slightly Torn Grain or similar defect which can be readily removed by the ordinary method of sanding the floor after it is laid; slightly Shallow Place not over 12" long on underside of the flooring if it does not extend to either end of the piece. Pieces with 1/2 Tongue for no more than 25% of the length are allowed. The wood must be sound and free of Shake. Bark Streaks shall not be permitted.

Bundles shall be 1-1/4' and longer through 7' or 8' as the stock will produce. Not over 55% of the total footage shall be in bundles under 4'; Not more than 25% of the total footage shall be in 2' bundles, and not more than 10% of the footage shall be in 1-1/4' bundles.

Nested bundles: Maximum average number of pieces under 1-1/4' shall be 8 pieces. Average length is 3'.

### **NOFMA No. 1 common Beech, Birch & Hard Maple**

A floor with varying wood characteristics and colors to include distinct color variations, numerous Streaks, stained Sapwood, sound Knots, and Checks. All defects must readily fill.

Will admit the following:

sound tight Knots, provided they do not occur on edges or ends of strips; slight Imperfections in machining; distinct Color Variations; Sticker Stain/Shadow; numerous dark Green or Black Spots or Streaks, provided they do not occur in combination with predominantly dark heartwood; slight Checks not exceeding 3" in length (may be slightly open) and running parallel with and well inside the edges and ends of the strips; dark Spots or Streaks with slight Checks in center; small Rough Spots (Torn Grain) which

## **Appendix BA, Guide to Hardwood Flooring Grades**

cannot be wholly removed by ordinary method of sanding the floor after it is laid; slightly Torn Edges; Short Tongue if sufficient to hold properly in the floor; Shallow or Waney Back, if piece has sufficient bearing of full thickness to support it in the floor; small bark Streaks where bark is as sound as surrounding wood; and slight variation in Angle of End Matching. The face shall be free of Shake and wood must be sound.

Bundles shall be 1-1/4' and longer through 7' or 8', as the stock will produce. Not over 60% of the total footage shall be in bundles under 4'; not more than 27% of the total footage shall be in 2' bundles; and not more than 15% of the footage shall be in 1-1/4' bundles.

Nested bundles: Maximum average number of pieces under 1-1/4' shall be 12 pieces. Average length is 2-3/4'.

### **NOFMA No. 2 common Beech, Birch & Hard Maple**

Must be of such character as will lay and give a good serviceable floor. The wood must be firm, serviceable and may contain all defects common to Maple. Pieces with 1-1/4' full Tongue admitted.

Third Grade will not admit:

Knot Holes over 3/8" in diameter or unsound Knots where the unsound portion is over 1" in diameter; Voids on Ends or Edges; or Shake, Heart Checks, badly Split Ends and Imperfections in Manufacture which would materially impair the serviceability of the floor.

Bundles shall be 1-1/4' and longer through 7' or 8', as the stock will produce. Not over 85% of the total footage shall be in bundles under 4'; and not more than 55% of the total footage shall be 1-1/4' bundles.

Nested bundles: Maximum average number of pieces under 1-1/4' shall be 42. Average length 2-1/4'.

### **NOFMA No. 1 common and better Beech, Birch & Hard Maple**

A combination of FIRST GRADE and SECOND GRADE developing from the production run. The lowest grade pieces admissible shall not be less than SECOND GRADE.

Bundles shall be 1-1/4' and longer through 7' or 8' as the stock will produce. Not over 60% of the total footage shall be in bundles under 4'. Not more than 27% of the total footage shall be in 2' bundles; and Not more than 15% of the footage shall be 1-1/4' bundles.

## **Appendix BA, Guide to Hardwood Flooring Grades**

Nested bundles: Maximum average number of pieces under 1-1/4' shall be 12 pieces. Average length 2-3/4'.

### **NOFMA No. 2 common and better Beech, Birch & Hard Maple**

A combination FIRST GRADE, SECOND GRADE, and THIRD GRADE developing from the production run. The lowest grade pieces admissible shall not be less than THIRD GRADE.

Bundles shall be 1-1/4' and longer through 7' or 8', as the stock will produce. Not over 60% of the total footage shall be in bundles under 4'.

Nested bundles: Maximum average number of pieces under 1-1/4' shall be 42. Average length 2-1/4'.

### **SPECIAL GRADES FOR BEECH, BIRCH & HARD MAPLE**

#### **NOFMA Clear White Maple Hard Maple**

Is special stock, selected for uniformity of color. It is almost ivory white and is the finest grade of Hard Maple flooring that can be produced. Sapwood/Heartwood pieces must have 95% Sapwood on the face. Strips must be free from stain and Heartwood portion must be nearly white. All FIRST GRADE rules apply.

EXCEPTIONS: Streaks- should be light brown or light green, not over 1/4" wide and 3" long (or equivalent), one per 3'. Black Spots, Sticker Stain/Shadow, not admitted.

#### **NOFMA Clear Red Beech & Birch**

Are special grades produced from all red faced stock, and are specially selected for color. The color is rich, being a soft tint which lends these two woods an individuality found in no other species. Strips must have 95% red faced characteristics. All FIRST GRADE rules apply.

EXCEPTIONS: Streaks- should be light brown, Black Spots, Sticker Stain/Shadow, not admitted.

## **Appendix BA, Guide to Hardwood Flooring Grades**

### **HICKORY/PECAN GRADING RULES**

#### **NOFMA Select and better**

##### **Hickory / Pecan**

Shall have the face practically free of all defects, but the natural color of the wood shall not be considered a defect. The highest standard grade, combines a nearly uniform appearance with exceptional durability.

The following characters are admitted:

variations in the Natural Color of the wood, Heartwood and Sapwood; an occasional small, firm Pin Knot or Bird Peck, not over 1/8" in diameter, provided it does not occur on edges or ends of strips; dark Streaks not over 1/4" wide and 3" long (or its equivalent one for every 3 ft. in length); slight Checks not over 1/2" long, provided Check is boxed within the piece; small Burls; slight Torn Grain or slight intermittent Machine Burn, or similar defect which can be readily removed by the ordinary method of sanding the floor after it is laid; A slightly Shallow Place not over 12" long on underside of the flooring if it does not extend to either end of the piece. Pieces with 1/2 tongue for no more than 25% of the length are allowed. The wood must be free of Shake. Bark Streaks shall not be permitted.

Packaging: 8' or shorter, Nested or Bundled. Pieces/Bundles shall be 1-1/4' and longer through 7' or 8' as the stock will produce (9" Minimum, 102" Maximum). Average length 3 1/4'. Average length for 7' and shorter packages, nested or otherwise - 3'.

#### **NOFMA No. 1 common**

##### **Hickory / Pecan**

A floor with varying wood characteristics and colors to include heavy Streaks, stained Sapwood, sound Knots, Checks and small Splits. All defects must readily fill and be sound.

The following characteristics are admitted:

Broken Knots up to 1/2" in diameter; distinct Color Variations (predominantly dark, discolored pieces not allowed); Sticker Stain/Shadow; numerous dark Streaks or black spots; Checks to 1/16" not exceeding 3" in length, and running parallel and well inside the strip edges; small End Split 1/16" x 1/2" showing no movement; Bird Pecks to 1/2" where bark is sound and as hard as surrounding wood.

Minor imperfections in machining permitted; Torn Grain (less than 1/16" deep and 3" long for full width); slightly Torn Edges; and an occasional dark Machine Burn 1/2" in width (1 per 3').

Will admit pieces with 1/2 full Tongue entire length of piece.



## **Appendix BA, Guide to Hardwood Flooring Grades**

Packaging: 8' or shorter, Nested or Bundled. Pieces/Bundles shall be 1-1/4' and longer through 7' or 8' as the stock will produce (9" Minimum, 102" Maximum). Average length 2-3/4'. Average length for 7' and shorter packages, nested or otherwise- 2-1/2'.

### **NOFMA No. 1 common and better Hickory / Pecan**

A combination of FIRST GRADE and SECOND GRADE developing from the production run. The lowest grade pieces allowed are SECOND GRADE.

Packaging: 8' or shorter, Nested or bundled. Pieces/Bundles shall be 1-1/4' and longer through 7' or 8' as the stock will produce (9" Minimum, 102" Maximum). Average length 2-3/4'. Average length for 7' and shorter packages, nested or otherwise-2-1/2'.

### **NOFMA No. 2 common Hickory / Pecan**

Must be of such character as will lay and give a good serviceable floor. The wood must be firm, and may contain defects of every character. This grade is intended to give a "rustic" appearance.

The following defects are not allowed:

Knot Holes over 3/8" in diameter or unsound Knots where the unsound portion is over 1" in diameter (the unsound portion can not extend through piece); Shake, Soft Rot, Splits and open defects which extend through piece or show movement; Torn Grain more than 1/4" deep; Edge Splinters; and Imperfections in Manufacture which would materially impair the serviceability of the floor.

Knot Holes, Bird Pecks, Worm Holes, and the like which will readily fill are admitted. Pieces with 1/4 full tongue admitted.

Packaging: 8' or shorter, Nested or bundled. Pieces/Bundles shall be 1-1/4' and longer through 7' or 8' as the stock will produce (9" Minimum, 102" Maximum). Average length 2-1/4'. Average length 7' and shorter packages, nested or otherwise-2'.

### **NOFMA No. 2 common and better Hickory / Pecan**

A combination of FIRST GRADE, SECOND GRADE, and THIRD GRADE developing from the production run. The lowest graded pieces allowed are THIRD GRADE.

Packaging: 8' or shorter, Nested or bundled. Pieces/Bundles shall be 1-1/4' and longer through 7' or 8' as the stock will produce (9" Minimum, 102" Maximum). Average length 2-1/4'. Average length for 7' and shorter packages, nested or otherwise-2'.

## **Appendix BA, Guide to Hardwood Flooring Grades**

### **SPECIAL GRADES**

#### **Hickory / Pecan**

#### **NOFMA Clear Red**

#### **Hickory / Pecan**

Is a special stock selected for its deep red/brown color with the minimal contrast of lighter Sapwood.

Face of pieces shall be Heartwood (95%).All First Grade Rules apply.

#### **NOFMA Clear White**

#### **Hickory / Pecan**

Is special stock selected for its creamy color with the minimal contrast of the darker Heartwood. The face of pieces shall be bright Sapwood (95%). All First Grade Rules apply.

EXCEPTIONS: Streaks should be light brown not over 1/4" wide and 3" long (or equivalent) one per 3'. Black Spots not allowed,Sticker Stain/Shadow none allowed.

#### **NOFMA No. 1 common red**

#### **Hickory / Pecan**

Is special stock selected for minimal contrasting lighter Sapwood. The face of pieces shall be Heartwood (85%).All Second Grade rules apply.

### **ASH GRADING RULES**

#### **NOFMA CLEAR ASH**

The face shall be practically free of defects

The following characters are admitted:

Small burls (less than 1/8" diameter; Fine pin worm holes with no discoloration (1 for every 3' in length); or in the absence of these,one (1) thin light brown streak (3' long to be allowed for every 6' of length or equivalent

Brown Heartwood is allowed as follows: 3/8" entire length or one 1" for one-third the length of the strip

Clear Ash is usually chosen for it's light color. Bundles to be 1-1/4' and up. Average length (Standard Packaging) 3-3/4'. Average length for shorter packaging, nested or otherwise, 3-1/2'.

#### **NOFMA SELECT ASH**

The face shall contain mostly Sapwood, unstained.

The following characters are admitted:

## Appendix BA, Guide to Hardwood Flooring Grades

Narrow streaks not running entire length of the strip; Pin worm holes (up to 3 every 3' in length); Imperfections in milling (Torn grain) which will sand out; One (1) small tight knot (1/4' in diameter) to every 3' in length; Small pith fleck (less than 1/4" diameter); An intermittent brown machine burn across the face not exceeding 1/4" in width; and Unlimited cambium miners.

Brown Heartwood is allowed as follows: 3/8" entire length or 1" for one-third the length of the strip.

Will admit pieces with 1/2 tongue. Most defects are lost sight of after the floor is laid and finished, giving a good appearance

Bundles to be 1-1/4' and up. Average length (Standard Packaging) 3-1/4'. Average length for Shorter Packaging, nested or otherwise, 3'.

### **NOFMA NO. 1 COMMON ASH**

A floor with varying wood characteristics such as Heavy streaks, Stained sapwood, and Sound knots typical of this grade. All defects must readily fill and be sound

The following characters are admitted:

Broken knots up to 1/2" in diameter; Pith flecks less than 3/16" in diameter; Worm holes up to 3/16" in diameter; Checks and End splits less than 1/16" in depth wide and not extending through the piece and Sticker stain

Minor imperfections in machining permitted Torn grain (not over one-fourth (1/4) of the surface, less than 1/16" in depth); One (1) dark machine burn across the face for every 3' of length not exceeding 1/2" in width, 1/64" in depth.

Will admit pieces with 1/4 tongue. Bundles to be 1-1/4' and up. Average length (Standard Packaging) 2-3/4'. Average length for Shorter Packaging, nested or otherwise, 2-1/2'.

### **NOFMA NO. 2 COMMON ASH**

Defects of every character admitted, but should lay a serviceable floor.

The following defects are NOT allowed:

Soft rot; Broken knots where the unsound portion extends through the piece; Torn grain over 3/16" in depth; Splits and Open defects extending through the piece; Shake and Pith flecks that are soft if over 1/4" in diameter.

Knot holes and defects which will readily fill are admitted.

A limited number of pieces with no tongue and limited number of pieces that are thin (scant) in thickness but will End Match admitted. Bundles to be 1-1/4' and up Average length (Standard Packaging) 2-1/4'. Average length for Shorter Packaging, nested or otherwise, 2'.

## **Appendix BA, Guide to Hardwood Flooring Grades**

### **PREFINISHED SOLID OAK FLOORING GRADING RULES**

White Oak and Red Oak in STANDARD & BETTER Grades with a natural coloration to be separated. All other colors and grades may be mixed Red Oak and White Oak. Grades are established after the flooring has been sanded and finished.

#### **NOFMA PRIME PREFINISHED OAK**

This is the top grade and the overall appearance shall be good. The face of strips shall be selected for appearance after finishing. This grade includes characteristics found in the unfinished grades of CLEAR and SELECT.

The following characters are admitted:

Unlimited Sapwood and the natural variations of color; Occasional small Burls; Light brown Streaks not more than 1/8" in width and 6" in length or the equivalent; an occasional very small tight 1/8" Knot; and limited 1/32" fine Pinworm Holes may be included in any one piece when properly filled. Will not admit pieces with less than 3/4 full tongue.

Minimum average length 3-1/4'. Bundles 1-1/4' and up.

#### **NOFMA STANDARD PREFINISHED OAK**

The face of strips may contain sound wood characteristics which are even and smooth after filling and finishing. This grade includes some characteristics found in the unfinished grades: SELECT, NO. 1 COMMON, and NO. 2 COMMON.

The following characters are admitted:

Worm holes; Season and Kiln Checks, Broken Knots up to 3/8" in diameter; minor imperfections in machining; Tom Grain and Burns. Other characters will be admitted if they do not impair the soundness of the floor. All larger admitted open characters are to be properly filled and finished. Limited unfinished/unfilled small open grade characters permitted.

Large Grub Worm Holes, Splits extending through the piece, Shake and similar unsound defects not admitted.

For naturally finished coloration- All the varying color characteristics of the wood admitted to include: Sticker Stain, and Dark Streaks up to 3/8" in width not to exceed 1" in length for each lineal foot.

For stained finishes- All varying colorations and streaks permitted, predominantly dark boards not permitted.

Minimum average length 2-1/2'. Bundles 1-1/4' and up.

## **Appendix BA, Guide to Hardwood Flooring Grades**

### **NOFMA STANDARD & BETTER PREFINISHED OAK**

A combination of PRIME and STANDARD grade developing from the production run.

Minimum average length 2-1/2'. Bundles 1-1/4' and up.

### **NOFMA TAVERN PREFINISHED OAK**

Should lay a serviceable floor.

A limited amount of unfilled/unfinished open characters admitted. A limited amount of pieces with finish irregularities such as bubbles, small skips, lines, stain/color variation, surface handling scratches, minor trash, and the like are allowed.

The following characters are NOT admitted: Mis-manufactured boards; Shattered or Rotten ends; large open knots and other unsound defects of a similar nature; Pieces with less than 1/4 full tongue.

Minimum average length 2'. Bundles 1-1/4' and up.

### **NOFMA TAVERN & BETTER PREFINISHED OAK**

A combination of PRIME, STANDARD, and TAVERN grades developing from the production run.

Minimum average length 2'.

# SECTION V

## APPENDIX CA

### FASTENER SCHEDULE

**(Fastener Schedule includes all fastening devices including, but not limited to nails, staples and cleats.)**

Hardwood Flooring must be installed over a proper subfloor. Tongue and Grooved MUST be Blind Nailed, Square Edge (no T & G) must be Face Nailed.

A slab with screeds 12" (300mm) o.c. for 33/32 does not always require a subfloor. A slab with screeds 9" (225mm) o.c. for third grade or equivalent does not always require a subfloor.

#### STRIP T & G

**Blind Fastener Spacing along the length of strips. Min. 2 nails per piece near the ends. (1"-3") (25mm-75mm)**

#### Size Flooring

#### Size Fastener to be Used

3/4 X 1 1/2" ,  
2 1/4" &  
3 1/4"

2" (50mm) barbed flooring cleat  
7d or 8d screw or cut  
nail, 2" 15 gauge  
staples with 1/2" crown.  
On slab with 3/4"  
underlayment subfloor use  
1 1/2" barbed fastener.

In addition –  
10-12" apart–  
8-10" preferred.

#### MUST INSTALL ON A SUBFLOOR

1/2 X 1 1/2" & 2"

1 1/2" barbed flooring cleat  
fastener, 5d screw, cut  
steel or wire casing nail

10" apart  
1/2" flooring  
must be installed  
over a MINIMUM  
5/8" thick plywood  
subfloor.

3/8 X 1 1/2" & 2"

1 1/4" barbed flooring cleat  
4d bright wire casing nail.

8" apart

## Appendix C, Fastener

### SQUARE EDGE FLOORING (NO T&G)

5/16 X 1 1/2" & 2"	1" 15 gauge fully barbed flooring brad.	2 nails every 7"
5/16 X 1 1/3"	1" 15 gauge fully barbed flooring brad.	1 nail every 5" on alternate sides of strip.

### PLANK

3/4 X 4" to 8"	2" barbed flooring cleat 7d or 8d screw or cut nail, or 2" 15 gauge staple with 1/2" crown Use 1 1/2" length with 3/4" plywood subfloor on slab.	8" apart
----------------	--	----------

FOLLOW Manufacturer's instructions for installing Plank Flooring.

Widths 4" and over must be installed on a Subfloor of 5/8" or thicker plywood or 3/4" boards. On slab use 3/4" or thicker plywood.

# SECTION V

## APPENDIX AE

### MOISTURE BY AREA - CANADA

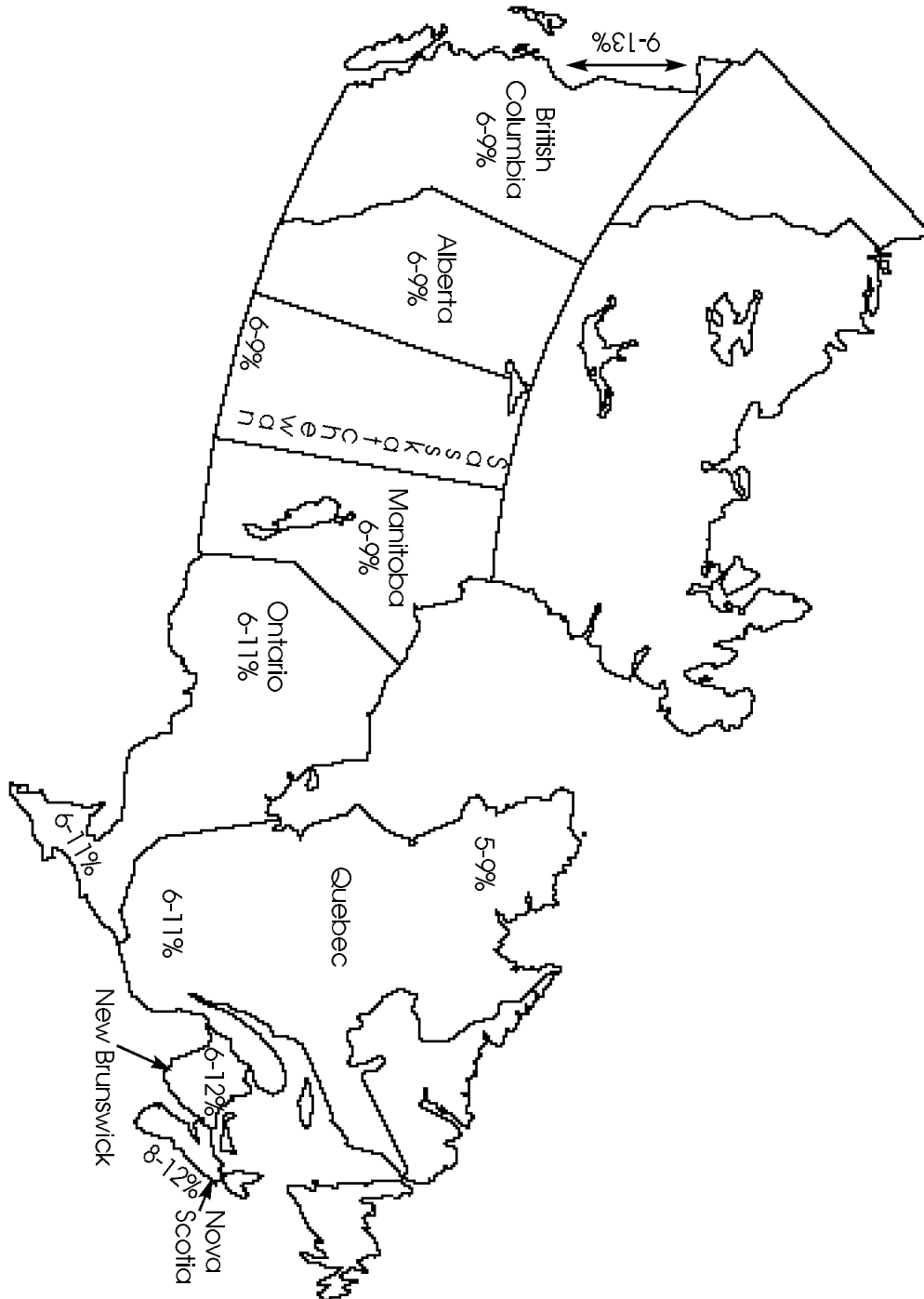

NOTE: Relative humidity in the building should be maintained between 30-50% year round. The key to wood floor performance is consistent environment.



# SECTION V

## APPENDIX DA

### APPLICATOR RECOMMENDATIONS

APPLICATOR TO USE	Oil Modified Urethane	Lacquer Sealer	Varnish Sealer	Moisture Cure Polyu	Shellac	Varnish	Wax	Stains	Water Base Urethane	Bleach	Conversion Varnish
100% Lambswool	X	X	X	X	X	X	X	X	X		X
Synthetic Lambswool	X		X			X	X	X	X		
Synthetic Pad	X								X		X
Rags							X	X		X	
Brush	X	X	X	X	X		X	X	X		X

Always follow the finish manufacturers recommended applicator.

# SECTION V

## APPENDIX DB

### FINISH CHART

Product	Respiratory Protection	Number of Coats	Drying Time	Color	Sheen	Odor	Flammability
Oil Modified Urethane	Required	2 - 3	Slow	Amber	Satin to Gloss	Moderate	Combustible
Water Based Urethane	Required	2 - 4	Fast	Clear To Amber	Satin to Gloss	Mild	Non-Combustible
Moisture Cured Urethane (MCU)	Required	2 - 3	Slow to Fast Depends on Humidity	Clear to Dark Amber	Satin to Gloss	Strong	Combustible to Flammable
Conversion Varnish	Required	2 - 3	Fast	Slight Amber to Clear	Satin to Gloss	Very Strong	Combustible
Wax	Optional	1	Fast	Slight Amber	Wax Luster	Mild	Combustible

# SECTION V

## APPENDIX DC

### ABRASIVE GUIDE

Sandpaper	Grit		Use
Open Coat	4-1/2	12	Remove Old Coatings
	4-0	16	
	3-1/2	20	
	3-0	24	
Coarse	2-1/2	30	Fast Cutting of Uneven Floors
	2-0	36	
	1-1/2	40	
Medium	1	50	1st Sanding - New
	1/2	60	2nd - Sanding-Old
Fine	1/0	80	Final Sanding New or Old
	2/0	100	
Extra Fine	3/0	120	For Very Fine Finish
	4/0	150	
<p><i>Use Only as Heavy Paper as it takes to do the job...</i></p> <p><b>Do Not Over-Sand!</b></p>			

# SECTION V

## APPENDIX DC

### GRADE SANDING SEQUENCE

Below is a graphic representation of what happens when a wood floor is sanded. As seen below, very little dimensions of the floor takes place after the initial cut with grade 36. Subsequent grades only serve to remove the scratch mark of the previous grade.

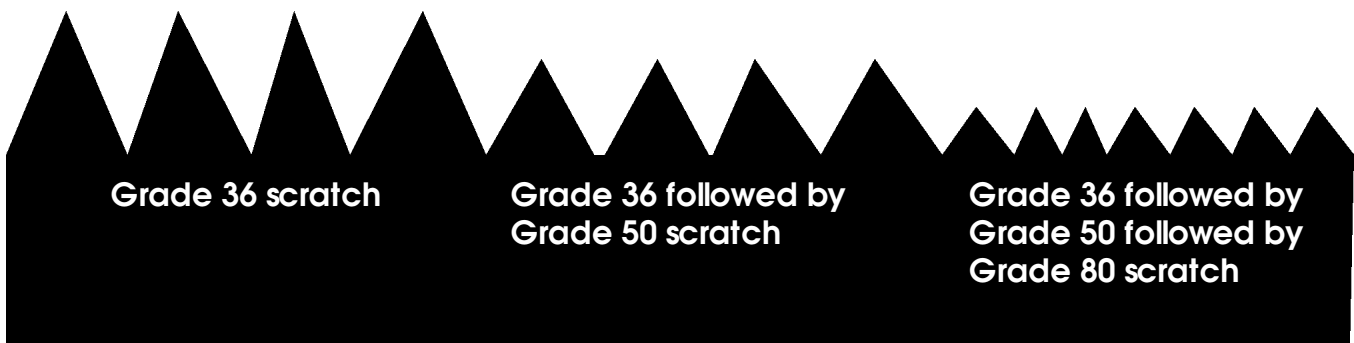

*It is normally recommended that only one grade be skipped in a sequence. The Drawing below shows what happens when too many grades are skipped.*



In Choosing a sequence, you select the finest grade you want to use and work toward the coarser grades. As an example, if you want to end up with grade 80 as the finest grade, a typical sequence might be 36 - 50 - 80. If you want the finest grade to be grade 100, you could use grades 40 - 60 - 100. When using a sequence of 36 - 60 - 100, the grade 60 will have a hard time removing the grade 36 scratches, the grade 100 will have little effect, if any, on the 36 scratches and will remove only the grade 60 scratches.

# SECTION V

## APPENDIX DD

### INTERCOAT ABRASION

Intercoat abrasion insures proper adhesion between coats of finish by creating a “profile” or tooth known as a mechanical bond. It also assists in achieving a smooth, even appearance after the final coat has dried by removing raised grain and irregularities in the prior coats. Fresh coats of finish may chemically bond without intercoat abrasion. Always follow the manufacturer’s recommendation.

- Use multiple angles for a visual inspection of imperfections in the floor such as debris, lap marks, drips, or swirl marks. Remember strong light highlights imperfections.
- Hand inspect to determine extent of problem. Then use scraper and/or sand paper to remove imperfection and finish by hand rubbing with abrasive pad.
- Sweep and vacuum, it is essential to start with an absolutely clean floor.
- Using the finish manufacturers recommended abrasive, hand abrade all edges or corners where buffer will not reach.
- Clean floor thoroughly as before.
- Load buffer with a steel wool pad, screen, abrasive pad, or abrasive pad with self adhering sandpaper strips as recommended by finish manufacturer.
- Abrade floor by running buffer with the grain or for parquet in the long direction of the room, overlapping passes by 1/2 the buffer width. Run buffer smoothly to avoid leaving swirl marks.
- Vacuum and tack with clean cloth wet with a solvent compatible with finish system.

#### Tacking Solvent Chart

waterbased urethane	water
oil modified urethane	mineral spirits
moisture cured urethane	xylene or water
acid cure urethane	denatured alcohol or water

- Apply next coat of the finish system as directed by manufacturer.

# SECTION V APPENDIX EA

NATIONAL WOOD FLOORING ASSOCIATION TECHNICAL PUBLICATION No. A400

## JOBSITE CHECKLIST

### I. GENERAL INFORMATION

Owner's Name \_\_\_\_\_ Date \_\_\_\_\_  
Address \_\_\_\_\_  
Home phone \_\_\_\_\_  
Husband's work phone \_\_\_\_\_ Wife's work phone \_\_\_\_\_  
Cellular/car phone \_\_\_\_\_ Pager \_\_\_\_\_  
Jobsite address \_\_\_\_\_  
Jobsite visit appointment date \_\_\_\_\_ Time \_\_\_\_\_

### II. TYPE OF JOB

Residential \_\_\_\_\_ Commercial \_\_\_\_\_  
New \_\_\_\_\_ Remodel \_\_\_\_\_

### III. RESIDENTIAL USE INFORMATION

Traffic High \_\_\_\_\_ Average \_\_\_\_\_ Low \_\_\_\_\_  
Any special or unique use \_\_\_\_\_  
Project rooms/areas \_\_\_\_\_  
Project budget \_\_\_\_\_

### IV. COMMERCIAL USE INFORMATION

Retail store \_\_\_\_\_ Restaurant \_\_\_\_\_ Office \_\_\_\_\_  
Bar \_\_\_\_\_ Other \_\_\_\_\_  
Traffic High \_\_\_\_\_ Average \_\_\_\_\_ Low \_\_\_\_\_  
High-rise Yes \_\_\_\_\_ No \_\_\_\_\_  
Freight elevator Yes \_\_\_\_\_ No \_\_\_\_\_  
Passenger elevator Yes \_\_\_\_\_ No \_\_\_\_\_  
Hours of access \_\_\_\_\_  
Power access \_\_\_\_\_  
Maintenance \_\_\_\_\_  
Maintenance company \_\_\_\_\_  
Phone \_\_\_\_\_  
Proximity of parking \_\_\_\_\_  
Cost of parking \_\_\_\_\_

### V. INTERIOR

Relative humidity in air-space:  
Hygrometer \_\_\_% Sling psychrometer \_\_\_%  
HVAC units operable Yes \_\_\_\_\_ No \_\_\_\_\_  
If, no, date to be operating \_\_\_\_\_  
Type of heat: \_\_\_\_\_  
Radiant \_\_\_\_\_ Baseboard \_\_\_\_\_ Radiator \_\_\_\_\_  
Forced Air \_\_\_\_\_ Electric \_\_\_\_\_ Gas \_\_\_\_\_  
Wood-burning stove Heat ducts \_\_\_\_\_  
Overhead \_\_\_\_\_ Under floor \_\_\_\_\_

Insulated Yes \_\_\_\_\_ No \_\_\_\_\_

Humidity controls Yes \_\_\_\_\_ No \_\_\_\_\_

### Thermostat setting

First unit \_\_\_\_\_ F Second Unit \_\_\_\_\_ F

Air conditioning Yes \_\_\_\_\_ No \_\_\_\_\_

### Large window/sliding glass doors facing:

East \_\_\_\_\_ South \_\_\_\_\_ West \_\_\_\_\_

Drapes Yes \_\_\_\_\_ No \_\_\_\_\_

Tinted glass Yes \_\_\_\_\_ No \_\_\_\_\_

Double-glazed/  
storm windows Yes \_\_\_\_\_ No \_\_\_\_\_

### KITCHEN:

Instant hot water Yes \_\_\_\_\_ No \_\_\_\_\_

Refrigerator Yes \_\_\_\_\_ No \_\_\_\_\_

Icemaker Yes \_\_\_\_\_ No \_\_\_\_\_

Food freezer Yes \_\_\_\_\_ No \_\_\_\_\_

Dishwasher Yes \_\_\_\_\_ No \_\_\_\_\_

Other \_\_\_\_\_

### MUD ROOM/LAUNDRY ROOM:

Clothes dryer  
vented outside Yes \_\_\_\_\_ No \_\_\_\_\_

Plumbing leaks \_\_\_\_\_

Ceiling stains \_\_\_\_\_

### BATHROOM

Bathroom exhaust Yes \_\_\_\_\_ No \_\_\_\_\_

Heated exhaust Yes \_\_\_\_\_ No \_\_\_\_\_

### BASEMENT

Walls cracked Yes \_\_\_\_\_ No \_\_\_\_\_

Paint peeling Yes \_\_\_\_\_ No \_\_\_\_\_

Floor stained Yes \_\_\_\_\_ No \_\_\_\_\_

Damp Yes \_\_\_\_\_ No \_\_\_\_\_

Vented Yes \_\_\_\_\_ No \_\_\_\_\_

Rusty nails Yes \_\_\_\_\_ No \_\_\_\_\_

# SECTION V APPENDIX EA

NATIONAL WOOD FLOORING ASSOCIATION TECHNICAL PUBLICATION No. A400

Sump pump            Yes \_\_\_\_\_ No \_\_\_\_\_

Condensation on  
cold-water lines    Yes \_\_\_\_\_ No \_\_\_\_\_

Musty smell            Yes \_\_\_\_\_ No \_\_\_\_\_

Heated                Yes \_\_\_\_\_ No \_\_\_\_\_

Air-conditioned      Yes \_\_\_\_\_ No \_\_\_\_\_

Relative humidity in air-space:  
Hygrometer \_\_\_%    Sling psychrometer \_\_\_%

## VI. EXTERIOR

Building is over  
Basement \_\_\_ Crawl space \_\_\_ Slab \_\_\_

Relation of lot to street  
Above \_\_\_ Level \_\_\_ Below \_\_\_

Lot cut and fill        Yes \_\_\_\_\_ No \_\_\_\_\_

Relation of lot to neighbor  
Above \_\_\_ Level \_\_\_ Below \_\_\_

Lot drainage away from foundation  
Yes \_\_\_\_\_ No \_\_\_\_\_

Shaded Lot            Yes \_\_\_\_\_ No \_\_\_\_\_

Gutters/downspouts Yes \_\_\_\_\_ No \_\_\_\_\_

Directed away        Yes \_\_\_\_\_ No \_\_\_\_\_

Roof overhang        Yes \_\_\_\_\_ No \_\_\_\_\_

**Foundation perimeter**

Waterproof            Yes \_\_\_\_\_ No \_\_\_\_\_

Soil damp              Yes \_\_\_\_\_ No \_\_\_\_\_

Window wells-dry    Yes \_\_\_\_\_ No \_\_\_\_\_

Planterbox            Yes \_\_\_\_\_ No \_\_\_\_\_

Shrubs/flowers        Yes \_\_\_\_\_ No \_\_\_\_\_

Comments \_\_\_\_\_

Yard established      Yes \_\_\_\_\_ No \_\_\_\_\_

Recent                 Yes \_\_\_\_\_ No \_\_\_\_\_

Sprinklers/irrigation Yes \_\_\_\_\_ No \_\_\_\_\_

Excess Watering      Yes \_\_\_\_\_ No \_\_\_\_\_

Entry is:  
Step up \_\_\_\_\_ Level \_\_\_\_\_ Down \_\_\_\_\_

Swimming pool        Yes \_\_\_\_\_ No \_\_\_\_\_  
In-ground \_\_\_\_\_ Above-ground \_\_\_\_\_

Distance from pool to foundation \_\_\_\_\_ feet

Drains in pool deck  
and/or patio            Yes \_\_\_\_\_ No \_\_\_\_\_

Is street curb  
drain active            Yes \_\_\_\_\_ No \_\_\_\_\_

**CRAWL SPACE:**

Distance from soil to subfloor \_\_\_\_\_

Condensation        Yes \_\_\_\_\_ No \_\_\_\_\_

Musty Smell            Yes \_\_\_\_\_ No \_\_\_\_\_

Concrete Slab         Yes \_\_\_\_\_ No \_\_\_\_\_

Moisture barrier  
beneath concrete    Yes \_\_\_\_\_ No \_\_\_\_\_

Dirt floor              Yes \_\_\_\_\_ No \_\_\_\_\_

6- or 8- mil black poly  
cover over dirt        Yes \_\_\_\_\_ No \_\_\_\_\_

15sf open vent per  
1,000sf floor area    Yes \_\_\_\_\_ No \_\_\_\_\_

Vents open            Yes \_\_\_\_\_ No \_\_\_\_\_

Cross-ventilation    Yes \_\_\_\_\_ No \_\_\_\_\_

## VII. SUBFLOOR INFORMATION

*(Reference NWFA Installation Guidelines, Section 2, Chapter 2-7 for approved subfloor.)*

Existing Wood type:

3/4-inch CDX plywood \_\_\_\_\_

5/8-inch CDX plywood \_\_\_\_\_

23/32-inch OSB underlayment    grade \_\_\_\_\_

Solid board \_\_\_\_\_

Other \_\_\_\_\_

Renail                    Yes \_\_\_\_\_ No \_\_\_\_\_

Sand                      Yes \_\_\_\_\_ No \_\_\_\_\_

Damage                 Yes \_\_\_\_\_ No \_\_\_\_\_

Pet stains                Yes \_\_\_\_\_ No \_\_\_\_\_

Rot                        Yes \_\_\_\_\_ No \_\_\_\_\_

Other subfloor repair \_\_\_\_\_

Average moisture content in flooring \_\_\_\_\_%

Average moisture content in subfloor \_\_\_\_\_%

Average moisture content in sleepers \_\_\_\_\_%

Average moisture content in joists \_\_\_\_\_%

In areas or seasons of extreme moisture  
conditions, check moisture content in:

Adjacent baseboard \_\_\_\_\_%

Door trim \_\_\_\_\_%

Wood threshold \_\_\_\_\_%

Paint/finish lines  
exposed                 Yes \_\_\_\_\_ No \_\_\_\_\_

Trim pieces dislodged Yes \_\_\_\_\_ No \_\_\_\_\_

**SLAB:**

Relate elevation of slab surface to exterior soil  
line +/- \_\_\_\_\_ inches

Slab tested for moisture before install  
Yes \_\_\_\_\_ No \_\_\_\_\_

What test \_\_\_\_\_

Results \_\_\_\_\_

New slab \_\_\_\_\_ Date poured \_\_\_\_\_

Existing slab \_\_\_\_\_ Age \_\_\_\_\_

Float/grind slab        Yes \_\_\_\_\_ No \_\_\_\_\_

Install wood subfloor Yes \_\_\_\_\_ No \_\_\_\_\_

Moisture membrane    Yes \_\_\_\_\_ No \_\_\_\_\_

# SECTION V APPENDIX EA

NATIONAL WOOD FLOORING ASSOCIATION TECHNICAL PUBLICATION No. A400

## VI. FLOORING TYPES

Unfinished \_\_\_\_\_ Prefinished \_\_\_\_\_

Species \_\_\_\_\_

Size of flooring desired \_\_\_\_\_

Solid \_\_\_ Engineered \_\_\_ Floating floor \_\_\_

Strip \_\_\_ Plank \_\_\_\_\_ Parquet \_\_\_\_\_

### INSTALLATION:

Glued \_\_\_\_\_ Stapled \_\_\_\_\_ Nailed \_\_\_\_\_

Stain color \_\_\_\_\_

Sealer \_\_\_\_\_

Finish \_\_\_\_\_

Number of coats \_\_\_\_\_

Trim and moldings \_\_\_\_\_

Special layout Yes \_\_\_\_\_ No \_\_\_\_\_

If yes, type \_\_\_\_\_

## IX. SPECIAL REQUIREMENTS

### NEW CONSTRUCTION:

Power 110 \_\_\_\_\_ 220 \_\_\_\_\_

Distance to pole \_\_\_\_\_

Booster Yes \_\_\_\_\_ No \_\_\_\_\_

Time schedule for installation \_\_\_\_\_

Other trades \_\_\_\_\_

Wet work completion \_\_\_\_\_

### REMODEL:

Move furniture Yes \_\_\_\_\_ No \_\_\_\_\_

#### Special Needs

Piano \_\_\_ Antiques \_\_\_ Appliances \_\_\_

Toilet \_\_\_ Other \_\_\_\_\_

(Note: Gas and water lines must be disconnected by customer or qualified personnel.)

Company responsible \_\_\_\_\_

Phone \_\_\_\_\_

#### Existing floor covering

Carpet \_\_\_\_\_ Sheet vinyl \_\_\_\_\_

Vinyl tile \_\_\_ Ceramic tile \_\_\_

Wood \_\_\_\_\_ Other \_\_\_\_\_

#### Do existing wall moldings

need to be removed Yes \_\_\_\_\_ No \_\_\_\_\_

Does the existing floor covering need to be removed Yes \_\_\_\_\_ No \_\_\_\_\_

*Note: If it appears that floor covering could contain asbestos, check with the dealer/contractor company for proper abatement procedures.*

Who is responsible for removal of existing floor covering? \_\_\_\_\_

Who is responsible for trash disposal? \_\_\_\_\_

**Use graph paper like that below to sketch the dimensions of the installation to scale.**

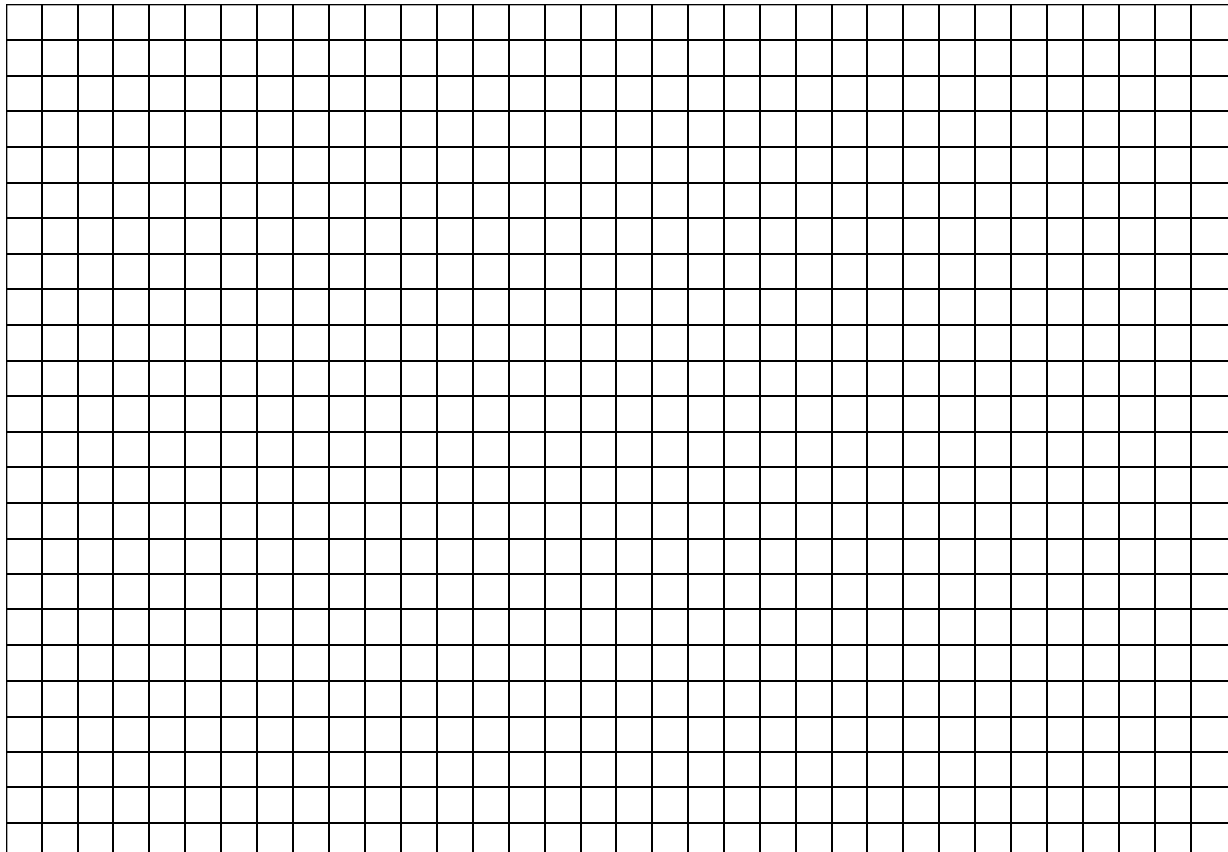



# SECTION V APPENDIX EB

## TOOLS CHECKLIST

Here is a basic list of tools to outfit the professional flooring contractor. Some may be supplied by the company, others you may have to supply yourself.

	Installation	Sanding	Finishing
Eye protection	■	▲	●
Knee pads	■	▲	●
Respirator	■	▲	●
Ear plugs	■	▲	●
Moisture meter	■		●
Nailing machines	■		
Assorted nails, cleats, pins	■		
Air tank, hoses and fittings	■		
Jigsaw	■		
Band saw	■		
Reciprocating saw	■		
Table saw	■		
Hand saw	■	▲	●
Jamb saw	■		●
Circular saw	■		●
Miter box with saw	■	▲	●
Chalk line	■		
Staplers	■		●
Squares	■		
Level/straight-edge	■		
Compass and protractor	■		
Scrapers, blades and files	■	▲	
Pry bar	■		
Drills and bits	■	▲	●
Router and bits	■	▲	●
Hammers	■	▲	●
Chisels	■	▲	●
Nail sets	■	▲	●
Pliers and wrenches	■	▲	●
Nail pullers	■	▲	●
Screwdrivers	■	▲	●
Rule or tape	■	▲	●
Block plane	■	▲	●
Utility knife	■	▲	●
Electric tester	■	▲	●
Keel or crayon	■	▲	
Fans	■	▲	●
Brooms	■	▲	●
Drop cord light	■	▲	●
General purpose oil (non-detergent for pneumatic tools)	■	▲	●
Extension cord, adequate, length, grounded	■	▲	●
Electric plugs, adapters	■	▲	●
Electrical tape	■	▲	●
Vacuum cleaner	■	▲	●
Plastic bags for waste	■	▲	
Sanders		▲	
Edger		▲	
Oscillating sanders		▲	●
Buffers		▲	●
Sander cords		▲	
Sander bags			●
Applicators, brushes			
Trowels	■		

# **S E C T I O N VI**

## **Glossary of Terms**

# GLOSSARY OF TERMS

**Abrasion Resistance** That property of a surface that resists being worn away by a rubbing or friction process. Abrasion resistance isn't necessarily related to hardness, as believed by some, but is more closely comparable to, or can be correlated with, toughness.

**Acclimation** The act of allowing wood moisture content to become at equilibrium with the environment in which it will perform (See EMC, Equilibrium Moisture Content)

**Acid** Chemical substance rated below 7 on the PH scale

**Acrylic Resin** A synthetic resin, white in color, very transparent, and resistant to discoloration, moisture, alcohol acids, alkalis and mineral oils. It is usually made by polymerization of acrylic acid and methacrylic acid.

**Acrylic/Wood** The generic name for wood-plastic composites using wood impregnated with acrylic monomers and polymerized within the wood cells by gamma irradiation. Some versions are cured by heat radiation.

**Adhesion** The property that causes one material to stick to another. Adhesion is affected by the condition of the surface to be coated and by the closeness of contact, as well as by the molecular forces of the unlike substances. Thus, the surface should allow a certain amount of penetration, should be chemically clean and not too smooth, hard or nonporous for good adhesion.

**Adsorption** A type of adhesion that occurs at the surface of a solid or liquid in contact with another medium, thus allowing an increased number of molecules of the gas or liquid to become attached to the surface of the solid at the point of contact.

**Air-Dried** Dried by exposure to air in a yard or shed without artificial heat. (Not kiln dried)

**Alkalinity** A measurement of alkaline rated above 7 on the PH scale.

**Alligatoring** A finish that exhibits large segmented cracks with the appearance of an alligator hide. May be caused by heavy coating, coating over non-cured coatings, use of fast drying thinners or the application of a finish over another with less elasticity.

**Amber** A yellowish color change from either the wood or finish. See **Color Change**.

**Aniline Colors** Colors made from aniline oils or coal tar derivatives, and used in the manufacture of wood stains. Aniline dyes are made in different grades to be soluble in water, alcohol or hydrocarbons, and accordingly are called water colors, spirit colors and oil colors, respectively.

**Annual Growth Ring** The layer of wood growth, including spring – and summerwood, formed on a tree during a single growing season.

**Applicator Marks or Streaks** Associated with partially cured finishes. When an applicator is drawn across the surface of half-set finish, especially when applying a new section of finish, the lapped area is deglossed leaving a streak. Usually caused by thin films which have faster curing times than the surrounding area. May also be caused by inadequate agitation of satin and semi-gloss finishes which allows "settling" of glossing agents.

**Asphalt Saturated Felt Paper** A 15lb asphalt felt paper that meets ASTM Standard D4869 or 30/30/30 Asphalt laminated Kraft paper that meets federal specification UU-13-790A commonly used as a moisture retarder.

**ASTM** American Standard Testing Methods

**Base Shoe** A molding designed to be attached to baseboard molding to cover expansion space. It is the alternative to a quarter-round in profile.

**Bastard Sawn** See **Rift Sawn**.

**Beveled Edge** The chamfered or beveled edge of strip flooring, plank, block and parquet. See **Eased Edge**.

**Bleed Back** Most commonly associated with stains but may be caused by a slow drying finish system. Deep stain penetration, especially in spring wood, causes slow curing of the stain due to the absence of air flow and oxygen. When humidity rises or with the application of a finish the cell structure swells causing the stain to be squeezed out forming a small droplet on the surface of the floor or film. Wiping with a dry, white towel normally identifies the presence of the problem which can be prevented by buffing with a red or white pad.

**Bleeding** When the color of a stain or other coating material works up into succeeding coats, imparting to them a certain amount of color, it is said to bleed. A non-bleeding color is one that isn't soluble in materials used over it.

**Blistering** The formation of bubbles or pimples on the surface of finished work. It is caused by exposure to excessive heat, grease or other volatile material under the finish, by moisture in the wood or by the too frequent application of coats. Anything that causes a gas or vapor to form under the film may cause blistering.

**Blushing** The formation of a white or grayish cast in a spirit varnish, shellac or lacquer film during the drying period. It is caused by the partial or total precipitation of the solid ingredient as a result of condensed moisture in the film. This may be caused by excessive humidity or by use of an improper solvent.

**Board Foot** A unit of measurement of lumber represented by a board 1 foot long, 12 inches wide and 1 inch thick or its cubic equivalent. In practice, the board foot calculation for lumber 1 inch or more in thickness is based on its nominal thickness and width and the actual length. Lumber with a nominal thickness of less than 1 inch is calculated as 1 inch.

**Body** Often used to describe the consistency of viscosity of a finishing material. It's also used to describe the fullness or thickness of film on the work.

**Boiling Point** The temperature at which the vapor pressure of a liquid equals the air pressure, or the temperature at which a liquid begins to boil.

**Bond** The adhesion between two dissimilar materials.

**Borders** Simple or intricate designs which frame and customize a flooring installation.

**Bow** The distortion of lumber in which there is a deviation, in a direction perpendicular to the flat face, from a straight line from end to end of the piece.

**Brushability** The ease with which a material can be applied with a brush under practical conditions.

**Brush Marks** Marks of the brush that remain in the dried film of a finishing material. They are caused by working the material after its solvents have evaporated to the point that the flowing power has been lost or by defects in formulation that prevent the material from leveling out after it has been brushed.

**Bubbling** The appearance of bubbles in the film of finish while a finishing material is being applied. It is caused by any condition that causes air, vapors or gases to be trapped in the film while it's soft, but after it has hardened sufficiently to prevent the gas from escaping.

**Build Coat** A finishing material, usually of a transparent nature, used over the sealer or color coats and under the finishing coats to increase the fullness of the finished work.

**Burl** A swirl or twist of the grain of the wood that usually occurs near a knot, but doesn't contain a knot, commonly found in the stump of a tree and where limbs branch out from the tree.

**Chatter Marks** Slight indentations causing a ripple effect on the surface of a wood floor. They are usually caused by sanding machines that have out-of-balance drums, bad drive belts or foreign objects stuck to the wheels. The marks are most noticeable on gloss finishes, in direct-light areas or at eye level.

**Check** A lengthwise separation of the wood that usually extends across the rings of annual growth and commonly results from stress set up in wood during air or kiln drying.

**Checking** Similar to alligatoring, except that the finish is broken into smaller segments. Crowfoot checking is the name given to the defect when the breaks in the film form a definite three-prong pattern with the breaks running outward from a central point of intersection. When the checks are generally arranged in parallel lines, the defect is known as line checking. Irregular checks without a definite pattern are known as irregular checking.

**Chipping** The condition that occurs when a dried film of finishing material separates from the underneath surface in the form of flakes or chips. It is usually caused by insufficient elasticity or improper adhesion to the base material.

**Cleat** A barbed fastener commonly used as a mechanical device to fasten hardwood flooring.

**Color Change** Visual changes in the color of the wood species caused by exposure to light, deprivation of light and air, or some chemical reaction.

**Compression Set** Caused when wood strips or parquet slats absorb excess moisture and expand so much that the cells along the edges of adjoining pieces in the floor are crushed. This causes them to lose resiliency and create cracks when the floor returns to its normal moisture content.

**Coniferous** See **Softwoods**

**Conversion Varnish** See **Swedish Finish**.

**Crazing** The appearance of minute, interlacing cracks or checks on the surface of a dried film of finishing material.

**Crook** The distortion of a board in which there is a deviation, in a direction perpendicular to the edge, from a straight line from end to end of the piece.

**Cross Direction** Laying of material perpendicular to the material below it.

**Cross Pull** A condition occurring at an end-joint with the ends of flooring strips pulled in opposite directions.

**Crowfooting** A species of crystallization (See Checking) wherein the lines come together at a central point.

**Crowning** A convex or crowned condition or appearance of individual strips with the center of the strip higher than the edges. The opposite of cupping.

**Cupping** A concave or dished appearance of individual strips with the edges raised above the center. The opposite of crowning.

**Cure** To change the properties of a product by chemical action as opposed to drying when the product has reached its optimum state.

**Cut** To sand a floor. As a noun, cut refers to one pass over an area of floor with sanding equipment. Usually, a mechanic will make two or more cuts with progressively finer grits of sandpaper.

**Deciduous** See **Hardwoods**

**Deformed Nail**

**Delamination** The separation of layers in an engineered/laminate through failure within the adhesive or at the bond between adhesive and laminate.

**Diffuse-Porous Woods** Certain hardwoods in which the pores tend to be uniform in size and distribution throughout each annual ring or to decrease in size slightly and gradually toward the outer border of the annual growth ring. Hard maple is an example.

**Dimensional Stability** The ability to maintain the original intended dimensions when influenced by a foreign substance. Wood is hygroscopic (readily takes up moisture) and isn't dimensionally stable with changes in moisture content below the fiber saturation point. Engineered wood flooring, however, is more dimensionally stable than solid wood.

**Dispersed** In reference to finishing materials, finely divided or colloidal in nature.

**Distressed** A heavy artificial texture in which the floor has been scraped, scratched or gouged to give it a time-worn antique look. A common method of distressing is wire brushing.

**Drier** A catalytic material that improves the drying or hardening properties of oils or varnishes when added in small amounts. They are usually organic salts of lead, cobalt, manganese, zinc and iron, such as naphthenates, resinates and linoleates.

**Drying** The act of changing from a liquid film to a solid film by the evaporation of solvents, oxidation, polymerization or by a combination of these phenomena.

**Dry Tack-Free** The stage of solidification of a film of finishing material when it doesn't feel sticky or tacky when a finger is drawn lightly across it in a quick continuous motion.

**Dry to Sand** That stage of solidification of an applied film of finishing material when it can be sanded without undue softening, sticking or clogging of the sandpaper.

**Dry to Touch** That stage of drying of a film of finishing material when it has solidified sufficiently that it can be touched lightly without any of the finishing material adhering to the fingers.

**Drywall** Interior covering material, such as gypsum board, hardboard or plywood, that is applied in large sheets or panels.

**Durability** The ability of the wood species or finish to withstand the conditions or destructive agents with which it comes in contact in actual usage, without an appreciable change in appearance or other important properties.

**Dust** Small particles of solid matter. Also, a grading or size of natural resin.

**Dust-Free** That stage of solidification of an applied film of finishing material when dust that settles on the coated surface won't penetrate or stick to the film.

**Eased Edge** See **Beveled Edge**.

**End Joint** The place where two pieces of flooring are joined together end to end.

**End-Matched** In tongue-and-groove strip and plank flooring, the individual pieces have a tongue milled on one end and a groove milled on the opposite end, so that when the individual strips or planks are butted together, the tongue of one piece fits into the groove of the next piece. See **Side-Matched** and **Tongue-and-Grooved**.

**Engineered** An assembly made by bonding layers of veneer or lumber with an adhesive so that the adjacent layers have their grains going in opposite directions to increase dimensional stability.

**Epoxy, Epoxy Ester** A varnish that, with the addition of epoxy, creates a hybrid with the advantages of both products. Ambers well with quick build and high gloss but can be difficult to repair. Enhanced working characteristics make this finish a preferred choice for athletic surfaces. Dries to tack free in 8-24 hours, reaching full cure in 30 days.

**Equilibrium Moisture Content** The moisture content at which wood neither gains nor loses moisture when surrounded by air at a given relative humidity and temperature.

**Fading** The loss of color due to exposure to light, heat or other destructive agents.

**Feather Edge** The tapering of the edge of a film of dried material either by the method of application, sanding or rubbing the dried film, resulting in a gradual progression of the film thickness from little or no material at the edge to a normal coating at the center.

**Feature Strip** A strip of wood used at a threshold or to border a room or to otherwise serve as an accent. Usually of a contrasting color or species.

**Fiberboard** A broad generic term inclusive of sheet materials of widely varying densities manufactured of refined or partially refined wood or other vegetable fibers. Bonding agents and other materials may be added to increase strength, resistance to moisture, fire or decay, or to improve some other property.

**Fiber Saturation Point** The stage in drying or wetting wood at which the cell walls are saturated with water and the cell cavities are free from water. It's usually taken as approximately 30 percent moisture content, based on oven-dry weight.

**Figure** Inherent markings, designs or configurations on the surface of the wood produced by the annual growth rings, rays, knots and deviations from regular grain.

**Filler** In woodworking, any substance used to fill the holes and irregularities in planed or sanded surfaces to decrease the porosity of the surface before applying finish coatings. Wood filler used for cracks, knotholes, worm holes, etc..., is often a commercial putty, plastic wood or other material mixed to the consistency of putty. A wood filler may also be mixed on the job using sander dust from the final sanding, or other suitable material, mixed with sealer or finish.

**Fillets** The small components which comprise parquet. Also called fingers or slats.

**Fingers** See **Fillets**.

**Finger-block** Parquet made from small strips of wood assembled together. See **Fillets**.

**Fire Resistance** The property of a material or assembly to withstand fire or give protection from it. Certain species naturally provide greater fire resistance than others. Classes are I-II-III or A-B-C with Class I or A being the most fire resistant.

**Fire Retardant** A chemical or preparation of chemicals used to reduce flammability or to retard the spread of a fire over a surface.

**Fish Eyes** Also called cratering, crawling, holes, spots or flow marks. When caused by surface contaminants the finish is applied over areas in which the wetting agents cannot perform their function. The finish then recedes away from this area reforming into the film. This "crawling" creates round or elliptical areas lacking adequate finish. May also be caused by failing to properly agitate a finish prior to application. Without proper agitation properties within the finish may separate. The flattening and wetting agents will therefore not be in proper concentration and cause this appearance.

**Flag** A heavy dark mineral streak shaped like a banner.

**Flag Worm Hole** One or more worm holes surrounded by a mineral streak.

**Flame Spread** The propagation of a flame away from the source of ignition across the surface of a liquid or solid, or through the volume of a gaseous mixture. NOTE: Most wood species are Class C Flame Spread unless the wood floor has been treated and marked.

**Flattening Agent** A material added to a normally glossy coating to reduce luster and produce a flat appearance.

**Flecks** The wide, irregular, conspicuous figure in quartersawn oak flooring. See **Medullary Rays**.

**Flow** The characteristic of a coating that allows it to level or spread into a smooth film of uniform thickness before hardening.

**Ford Cup** A type of viscosimeter originally used by the Ford Motor Company, but now used extensively in testing laboratories. It consists of a cup with an overflow device to ensure a standardized volume, in the bottom of which is a standardized orifice. The number of seconds required for the cup to empty itself at a standardized temperature gives a numerical expression of the viscosity of the material.

**Gloss** The luster, shininess or reflecting ability of a surface.

**Glossing Up** The increase of luster in a rubbed film through friction in use or the increase in luster of a flat varnish in the package through a decrease in the effect of a flattening agent.

**Gloss Meter** An instrument for measuring the luster or gloss of a finished surface.

**Graininess** The objectionable appearance of small, grain-like particles in a finishing material or in the dried film thereof.

**Hardness** That property of the wood species or dried film of finishing material that causes it to withstand denting or being marked when pressure is exerted on its surface by an outside object or force.

**Hardwood** Generally, one of the botanical groups of deciduous trees that have broad leaves, in contrast to the conifers or softwoods. The term has no reference to the actual hardness of the wood.

**Heartwood** The wood extending from the pith to the sapwood, the cells of which no longer participate in the life processes of a tree. It is usually darker than sapwood. See **Pith** and **Sapwood**.

**Heavy Streaks** Spots and streaks of sufficient size and density to severely mar the appearance of wood.

**High Solids** A general term used to denote the presence of a higher than average percentage of solid ingredients and thus a lower percentage of solvents.

**Honeycombing** Checks often not visible at the surface that occur in the interior of a piece of wood, usually along the wood rays.

**Humidity** The amount of water vapor in the air. See **Relative Humidity**.

**Hygrometer** An instrument for measuring the degree of humidity or relative humidity of the atmosphere.

**Hygroscopic** A substance that can absorb and retain moisture, or lose or throw off moisture. Wood and wood products are hygroscopic. They expand with absorption of moisture and their dimensions become smaller when moisture is lost or thrown off.

**Impact Test** A test for determining the resistance to shattering of a dried film by dropping a weight onto the finish.

**Incompatible** Not capable of being mixed together without impairing the original properties of the materials being mixed. Mixing incompatible materials usually results in a separation of solid particles, cloudiness or turbidity.

**Intensity** The intensity of a color is its purity or degree of hue as seen by the eye.

**Intumesce** To expand with heat to provide a low-density film. The term is used in reference to certain fire-retardant coatings.

**Jointed Flooring** Strip flooring, generally birch, beech, hard maple or pecan, manufactured with square edges, not side-matched, but usually end-matched. It is used principally for factory floors where the square edges make replacement of strips easier.

**Joist** One of a series of parallel beams used to support floor or ceiling loads and supported in turn by larger beams, girders or bearing walls.

**Kauri-Butanol Valve** A measure of the solvent power of petroleum thinners, expressed as the number of milliliters of the product under test required to cause cloudiness or turbidity in 20 grams of a solution of kauri in butyl alcohol that has been prepared under standardized conditions.

**Kiln** (often pronounced "kill") A chamber having controlled air flow, temperature and relative humidity for drying lumber, veneer and other wood products.

**Kiln-Dried** Dried in a kiln with the use of artificial heat.

**Knot** The portion of a branch or limb that has been surrounded by subsequent growth of the stem. The shape of the knot as it appears on a cut surface depends on the angle of the cut relative to the long axis of the knot. In hardwood strip flooring, small and pin knots aren't more than one-half inch in diameter. A sound knot is a knot cut approximately parallel to its long axis so that the exposed section is definitely elongated.



**Lacquer** A finish containing nitrocellulose more often used as a sealer. The fast curing properties of this finish are created by using a solvent with a very low flash point which causes it to be very flammable. Ambers little, cures rapidly, but may water spot and become cloudy when applied in high humidity. Can be incompatible with some types of stains and topcoats. Dries to tack free in 10-30 minutes, reaching full cure in 4-8 hours.

**Lap** Used as a verb, lap means to lay or place one coat so its edge extends over and covers the edge of a previous coat, causing an increased thickness where the two coats are present, as compared to the single thickness on either side of the lap. As a noun, lap is that portion of a coat of finishing material that extends over the edge of and onto a previous coat.

**Leveling** The ability of a film to flow out free of ripples, pock marks, brush marks or other surface defects.

**Manufacturing Defects** Includes all defects or blemishes that are produced in manufacturing, such as chipped grain, torn grain, skips in dressing, hit-and-miss (a series of surfaced areas with skips between them), variation in machining, machine burn, and mismatching.

**Mechanic** A flooring installer.

**Medullary Rays** Strips of cells extending radially within a tree and varying in height from a few cells in some species to four or more inches in oak. The rays serve primarily to store food and transport it horizontally in the tree. On quartersawn oak, the rays form a conspicuous figure sometimes referred to as flecks. See **Flecks**.

**Milky** Having the appearance of milk or showing some whiteness, as when water is mixed with varnish or when a dried transparent film starts to turn white from moisture.

**Mineral Spirits** A solvent product used as a thinner and/or cleaner.

**Mineral Streak** Wood containing an accumulation of mineral matter introduced by sap flow, causing an unnatural color ranging from greenish brown to black.

**Mixed Media** A wood floor that is predominately of wood, but also incorporates other materials, such as slate, stone, ceramic, marble or metal.

**Moisture Content** The amount of moisture in wood expressed as a percentage of the weight of oven-dried wood. National Oak Flooring Manufacturers Association hardwood flooring is manufactured at 6 to 9 percent moisture content, with a 5 percent allowance for pieces up to 12 percent moisture content. Five percent of the flooring may be outside of this range.

**Moisture-Cure(d) Urethane** As the name implies, this finish cures in the presence of moisture and fails to do so in its absence of strongly ambering or available in non-ambering. Very stain, spot and water resistant, but requires very tight environmental control during application and curing. May cure too rapidly and flatten poorly when applied in very high humidity. Long delays in curing may occur in areas when humidity levels are quite low. The excellent abrasion resistance also makes this finish difficult to recoat. Dries to tack free in 8-24 hours, reaching full cure in 14-30 days.

**Mosaic Parquet** See **Parquet**.

**Muratic Acid** A diluted acid used to neutralize alkalinity of concrete subfloors.

**Nominal Size** As applied to timber or lumber, the size by which it is known and sold in the market; often different from actual size.

**Nonvolatile** That portion of a material which doesn't evaporate at ordinary temperatures; the solid substances left behind after the volatiles have evaporated.

**Nosing** A hardwood molding used to cover the outside corner of a step, milled to meet the hardwood floor in the horizontal plane, to meet the riser in the vertical plane. It is usually used on landings.

**Odor** That property of a substance which is perceptible by the sense of smell; the smell, scent or fragrance of a material.

**Oil-Modified Urethane** An oil based varnish enhanced with urethane. This hybrid ambers well and has good abrasion resistance. Curing may be delayed when humidity levels are high, which can lead to inadvertent damage such as scratches. Very stain and abrasion resistant, but has a long curing time. Dries to tack free in 8-36 hours, reaching full cure in 30-60 days.

**Open Grain** (finish) A failure of finish to form a film over areas of low density, normally associated with the softer spring wood. The finish is absorbed into the softer grain failing to form a film and causing a loss of sheen. While not considered a finish defect it can often be concealed by the application of an additional coat of finish.

**Orange Peel** A finish that exhibits a surface texture resembling the surface of an orange. Normally caused by rolling a finish that has cured excessively which freezes the roller pattern in the film. May also be caused by excessive air flow, the velocity of which freezes waves in the film when it sets.

**OSB** Oriented Strand Board commonly used as an underlayment material.

**Overwood** A flooring condition in which some wood pieces are raised above adjacent pieces leaving a slightly uneven surface.

**Parquet** A tile composed of individual slats assembled together. A square may or may not possess tongues and grooves to interlock, and isn't necessarily square or regular in dimension.

**Particleboard** A generic term for a material manufactured from wood particles or other ligno-cellulosic material and a synthetic resin or other suitable binder. Flakeboard is a particle panel product composed of flakes. Oriented strand board is a type of particle panel product composed of strand-type flakes that are purposely aligned in directions that make a panel stronger, stiffer and improves dimensional properties in the alignment directions over a panel of random flake orientation. Waferboard is a particle panel product made of wafer-type flakes. It is usually manufactured to possess equal properties in all directions parallel to the plane of the panel.

**Peeling** A defect in a dried film manifested by large pieces becoming detached from the under surface and coming loose in sheets or large flakes.

**Penetrating Stains** Stains that penetrate into the surface of the wood. They are usually made of dyes dissolved into liquids that easily penetrate the wood.

**Petroleum Spirits** Another name for mineral spirits.

**pH Value** The concentration of the hydrogen ion in a material. A pH value of 7 is considered neutral. Lower values are acidic; higher values are alkaline.

**Photo-sensitive** The property of some wood species which causes them to lighten or darken when exposed to light. See **Color Change**.

**Pigment** The fine, solid particles used for color or other properties in the manufacture of paint and enamel.

**Pigment Stains** Stains that get their color primarily from pigments mixed with binder and volatile thinners.

**Pin Holes, Pin Lines** (finish) Normally caused by finish flowing into low lying or less dense areas such as spring wood. This thicker film of finish allows gasses formed during curing to freeze in the film leaving a small crater. The finish fails to form a film in these areas as the finish is in the wood instead of on it. While not considered a finish defect it can often be corrected by the application of an additional coat of finish.

**Pin-Worm Hole** In hardwood flooring, a small round hole not more than 1/16-inch (1.5626MM) in diameter, made by a small wood-boring insect.

**Pith** The small, soft core occurring near the center of a tree trunk, branch, twig or log.

**Plain Sawn** The annual growth rings make an angle of less than 45 degrees with the surface of the piece. This exposes the pores of the springwood and dense summerwood of the annual growth ring in ring-porous woods to produce a pronounced grain pattern.

**Planer Bite** A deeper than intended groove cut into the surface of a piece of wood by planer knives.

**Plank** Solid or Engineered/Laminated boards 3" and wider designed to be installed in parallel rows. Edges may be beveled to simulate the appearance of Colonial American plank floors.

**Plywood** Board or panel made of cross-directional layers of wood for dimensional stability.

**Plugs** Dowels that simulate the Colonial American plugged or pegged plank look. They are used to cover countersunk screws when installing wood flooring or for decorative purposes in wood flooring.

**Polyurethane** A large molecule of chemically joined urethane units, having the capacity to solidify or "set". Irreversible when acted upon by heat, radiation or chemical crosslinking or curing agents. See **Urethane**.

**Prefinished** Factory-finished flooring that only requires installation.

**Puckering** The crinkling, shriveling or wrinkling of a coat of finishing material upon drying.

**Pure** Free of adulteration.

**Quantity** The amount, bulk, mass, weight or measure of a thing; a measure of its size or numbers.

**Quartersawn** The annual growth rings of wood form an angle of 45 degrees to 90 degrees with the surface of the piece. In quartersawn strips, the medullary rays or pith rays in ring-porous woods are exposed as flecks that are reflective and produce a distinctive grain pattern.

**Raised Grain** A roughened or fuzzy condition of the face of the flooring in which the dense summerwood is raised above the softer springwood but not torn or separated.

**Raw Materials** The natural, untreated or unprocessed materials from which varnishes or other coatings are made.

**Rays, Wood** See **Medullary Rays**.

**Reduce** To lower the viscosity of a material or to thin it by the addition of a solvent, thinner, varnish, oil, etc.

**Reducer Strip** A teardrop-shaped molding accessory for hardwood flooring, normally used at doorways, but sometimes at fireplaces and as a room divider. It is grooved on one edge and tapered or feathered on the other edge.

**Refinish** Sanding a previously finished floor to bare wood and applying new finish.

**Relative Humidity** Ratio of the amount of water vapor present in the air to that which the air would hold at saturation at the same temperature. It is usually considered on the basis of the weight of the vapor, but for accuracy should be considered on the basis of vapor pressures.

**Retarder** A slowly evaporating solvent that decreases the evaporation rate or slows up the drying of lacquers and similar materials.

**Rift Sawn** Lumber (primarily hardwoods) in which the annual rings make angles of 30 degrees to 60 degrees with the surface of the piece. Also known as bastard sawn.

**Ring-Porous Woods** A group of hardwoods in which the pores are comparatively large at the beginning of each annual growth ring and decrease in size, more or less abruptly, toward the outer portion of the annual growth ring. The large pores are springwood and the smaller pores are summerwood.

**Ring Shank Nail** Headed nail for underlayment installation with rings on the shaft (shank) to improve the holding characteristics.

**Sapwood** The wood near the outside of a tree. It is usually lighter in color than heartwood.

**Sawn** See **Plain Sawn**, **Quartersawn** and **Rift Sawn**.

**Scratches** Slight incisions, breaks, tears or indentations on the surface caused by abrasive friction.

**Screeds** Usually a 2-by-4 inch (50MM by 100MM) piece of wood laid flat side down and attached to a concrete subfloor to provide a nailing surface for tongue-and-groove strip flooring or a wood subfloor.

**Sealer** Any finishing material that is applied with the primary purpose of stopping the absorption of succeeding coats.

**Sealer-Wax Finishes** A combination of a sealer, generally varnish, with wax. Both the sealer and wax are normally burnished to enhance wear and appearance. Water spots and stains easily, but is simple to repair. Dries to tack free in 6-8 hours, reaching full cure in 7-14 days.

**Separation** The breaking up or segregation of two or more integral parts of a mixture into its component parts. In a varnish, this may take the form of the resin becoming insoluble in the other ingredients. In a paint or enamel, it may mean that a clear liquid portion forms above the pigmented portion. In liquid, there may be a segregation of layers of component liquids.

**Settling** The separation of a pigment or other solid ingredient from a coating material upon standing.

**Set to Touch** See **Dry to Touch**.

**Shade** The degree to a color, as a dark green. Also, the act of changing the tone or degree of a color by adding small quantities of other colors to it.

**Shake** A separation along the grain, the greater part of which occurs between the annual growth rings.

**Sheathing** The structural covering, usually boards of plywood, placed over exterior studding or rafters of a structure.

**Sheen** The degree of luster of the dried film of a finishing material. It is usually used to describe the luster of rubbed surfaces or of flat-drying materials.

**Shellac** A finish produced from a combination of alcohol and resins excreted by the Lac Beetle. Has good ambering, may become tacky when subjected to high humidity and lacks the high abrasion resistance of more modern finishes. Generally low in cost, this finish may water spot but is easy to use. Dries to tack free in 24 hours, reaching full cure in 30 days.

**Side-Matched** In tongue-and-groove strip and plank flooring, the individual pieces have a tongue milled on one side and a groove milled on the opposite side, so that when the individual strips or planks are placed side by side, the tongue of one piece fits into the groove of the next piece. See **End-Matched** and **Tongue and Groove**.

**Skin** The film of oxidized or polymerized finishing material that forms on the surface while in a container or tank.

**Slats** See **Fillets**.

**Sleeper** Another name for screeds.

**Slip-Tongue** A spline or small strip of wood or metal used to reverse or change direction in installing standard tongue-and-groove strip flooring. It is sometimes used in laying 3/4-inch (19MM) solid tongue-and-groove parquet.

**Softwoods** General term used to describe lumber produced from needle and/or cone-bearing trees (conifers).

**Solid Board Group 1** A designation of a certain species based on density, strength and stiffness.

**Split** Separations of wood fiber running parallel to the grain.

**Square-Edge** Flooring that isn't tongue-and-grooved. May also refer to square-edge strip flooring that is face-nailed when installed.

**Squares** Parquet flooring units, usually composed of an equal number of slats.

**Staining** The act of changing the color of wood without disturbing the texture or markings, through the application of transparent or semitransparent liquids made from dyes, finely divided pigments or chemicals.

**Streaks** See **Mineral Streaks**.

**Strip Flooring** Solid or laminated boards to be installed in parallel rows, produced in various thicknesses and widths. The strips are side-matched and end-matched (tongue-and-grooved). They are for nail-down installation directly to wood or plywood subfloors, or over wood screeds on concrete slab construction. Some types can also be glued directly to a concrete subfloor.

**Stud** One of a series of slender wood structural members used as supporting elements in walls and partitions.

**Surface** The outside or exterior boundary of any substance. One is said to surface the work when it is rubbed or sanded to a smooth, level plane.

**Surface Drying** When a coating dries on top, but remains relatively soft on the bottom, it's said to surface dry.

**Surface Tension** The inherent molecular attraction in liquids that causes them to diminish their surface area and thereby exhibit properties resembling those of a stretched elastic membrane.

**Swedish Finish** An acid curing conversion varnish that is very stain, water and spot resistant. Ambers little, but during curing may contain fumes that are harmful to plants and pets. Dries to tack free in 8-24 hours, reaching full cure in 14 days. Sometimes inaccurately defined as a urethane finish with wax applied.

**Tack-Free** That condition when a film of finishing material has reached the point that the surface can be touched lightly without a sensation of stickiness.

**Tack Rag** Used to remove dust after sanding or screening. May be used dry or with an appropriate liquid compatible with the finish to be used.

**Tensile Strength** The ability of a film to withstand pulling stresses.

**Thermoplastic** The property of softening when heated and hardening upon cooling.

**Thickness of Film** The body on the work after the film of finishing material has thoroughly dried.

**Tint** A color produced by the addition of another color to white paint or enamel. The act of adding the color to the white material is known as tinting.

**Titanium Dioxide (TiO<sub>2</sub>)** A white pigment used in paints and enamels primarily to increase hiding power and give greater brightness. It has a specific gravity of 3.9 and a relatively high oil absorption, which usually ranges from 20 to 26. The particle size is usually very small.

**Tongue and Groove** In strip, plank and parquet flooring, a tongue is milled on one edge and a groove cut on the opposite edge. As the flooring is installed, the tongue of each strip or unit is engaged with the groove of the adjacent strip or unit. See **End-Matched** and **Side-Matched**.

**Trim** The finish materials in a building at the floor of rooms (baseboard, base shoe, quarter round for example).

**Trowel Fill** Method to fill an entire floor or large area.

**Truss** Engineered or solid floor joist system.

**TSP** Tri Sodium Phosphate commonly used to remove surface contaminants from flooring.

**Ultraviolet** Light rays that are outside the visible spectrum at its violet end. These rays have a chemical effect upon the dried film of finishing materials. Ultraviolet light is commonly used in curing finishes at the factory for prefinished flooring. Ultraviolet light also causes woods to lighten or darken. See **Color Change**.

**Undercoats** Coats that are applied prior to the finishing or final coats.

**Unfinished** A product that must have stain and/or a finish applied after installation.

**Units** Four or more basic mosaic parquet squares, or four or more slats in 3/4-inch (19MM), usually made from tongue and groove strip flooring combined into a parquet unit.

**Urethane** A synthetic chemical structure formed by one of three specific chemical reactions. See **Polyurethane**.

**UV-Cured Polyurethane** A special type of polyurethane that is cured by subjecting it to a specific dosage of radiation in the form of ultraviolet light. See **Polyurethane** and **Ultraviolet**.

**V-Joint** See **Beveled Edge**.

**Vapor Barrier** A material, such as foil, plastic film or specially coated paper, with a high resistance to vapor movement, used to control condensation or prevent migration of moisture.

**Varnish** A finish that contains either natural or synthetic oils that are refined by boiling and cooking with the addition of dryers. Slow to cure, but can be accelerated by the addition of heat. When used as a sealer, it is often burnished with a buffer and pads, the friction of which accelerates the curing process. Ambers well, somewhat stain and spot resistant, but may be scratched easily when new due to slow curing time. Dries to tack free in 24-48 hours, reaching full cure in 30-60 days.

**Viscosity** A property of fluids, either liquid or gaseous, that can briefly be described as causing resistance to flow. Viscosity is the measure of the combined effects of cohesion and adhesion. It is one of the most important physical properties of an oil, varnish or lacquer. Viscosity is usually measured with the Gardner-Holdt Bubble Viscometer.

**Warping** Any distortion of a piece of flooring from its true plane that may occur in seasoning.

**Water-Base Urethane** A waterborne urethane that is fully cured and dries by water evaporation. See **Polyurethane**.

**Water-Based, Water Borne Finishes** This large family of finishes has a common trait of having the solids suspended in water which is used as the solvent. A clear, color free finish available as a one part, cross linked or as a two-part. Products using a cross-linker (catalyst) may have enhanced stain and abrasion resistance. Easy to apply with low odor and good stain resistance, but may raise grain during first and second coat. Fast drying and easy to recoat. Dries to tack free in 2-4 hours, reaching full cure in 14 days.

**Wax** Any of a number of resinous, pliable substances of plant or animal origin that are insoluble in water, partially soluble in alcohol, ether, etc. and miscible in all proportions with oils. It is used for making polishes and other products.

**Wiping Stains** Those stains, usually pigmented, that are applied and then wiped with a cloth to remove excess.

**Wire Brushed** A method for imparting an artificial texture or distressed appearance to the surface of hardwood flooring.

**Wood Filler** See **Filler**.

**Yellowing** See **Ambering**.

# SECTION V

## APPENDIX AF

### SUBFLOOR GRADE LEVELS

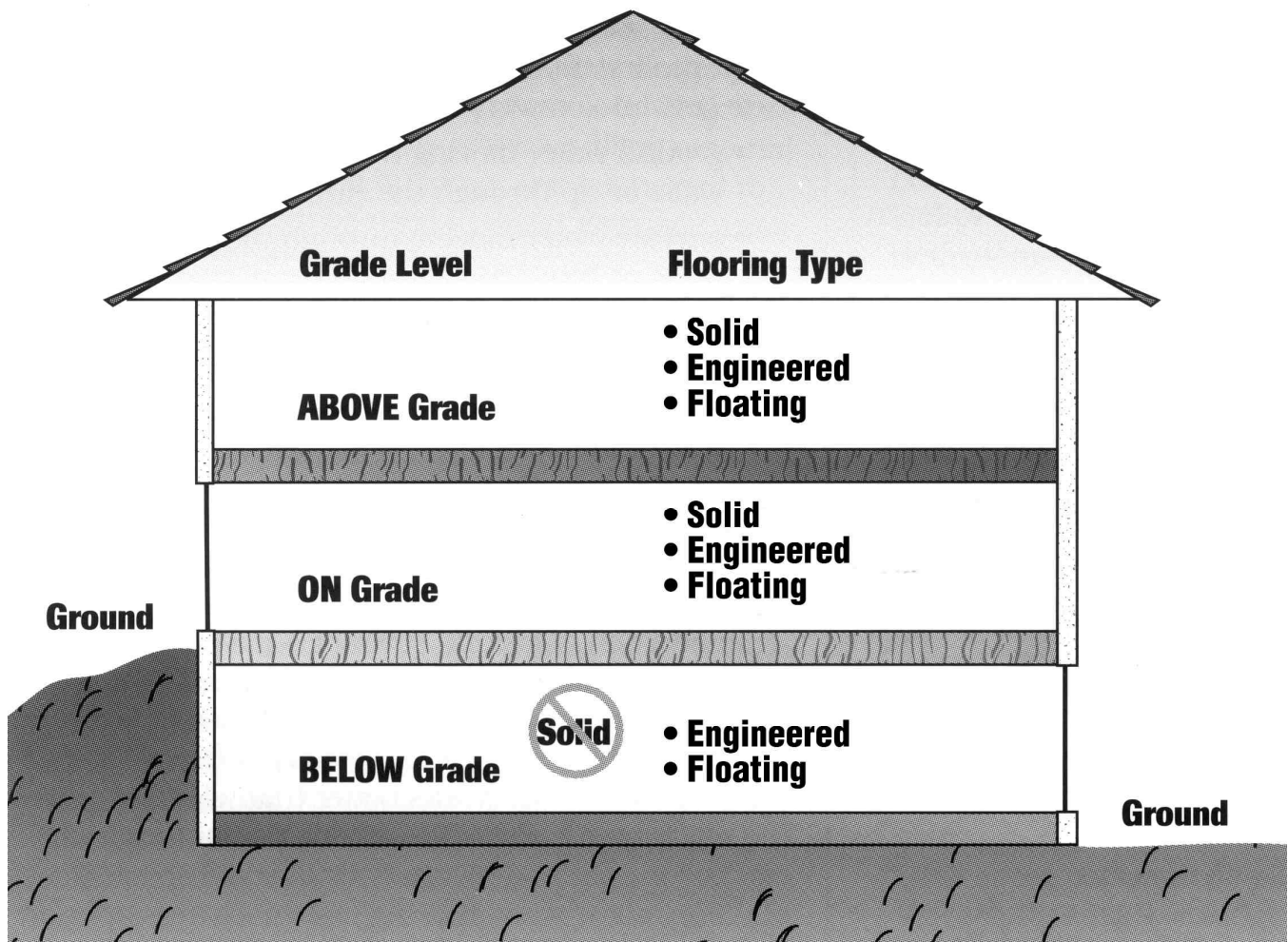

*If any part of the soil surrounding a structure is above the floor of any level, consider that level below-grade. This includes walk-out basements. In addition, the surrounding soil should be sloped away from the structure with at least 6 inches of fall over the first 10 feet.*